

THE FIVES

Klipsch®

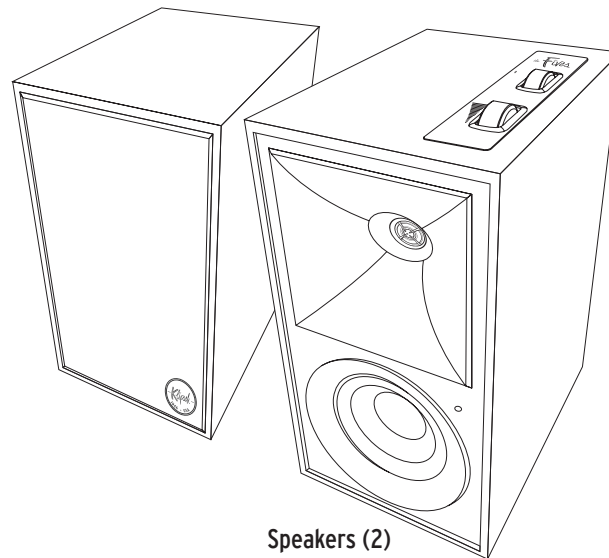

TABLE OF CONTENTS

- 2 - INSIDE
- 4 - RIGHT SPEAKER (ACTIVE)
- 6 - SETUP
- 7 - SELECT SOURCE
- 7 - CARE AND CLEANING
- 8 - HDMI ARC
- 9 - CONNECTIONS - TV
- 10 - CONNECTIONS - COMPUTER
- 11 - CONNECTIONS - TURNTABLE
- 12 - REMOTE
- 15 - *BLUETOOTH*[®] WIRELESS TECHNOLOGY
- 16 - SUBWOOFER OUTPUT
- 16 - LED SOURCE INDICATOR
- 17 - DYNAMIC BASS EQ
- 19 - FACTORY RESET
- 20 - REMOTE CONTROL CODES
- 20 - TROUBLESHOOTING

INSIDE

CONTENU • CONTENIDO • INHALT • CONTENUTO • CONTEÚDO • 目录



Speakers (2)

Speakers (2)

Enceintes (2)
Altavoces (2)
Lautsprecher (2)
Altoparlanti (2)
Caixas acústicas (2)
音箱 (2)

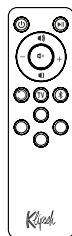

Remote



Manual

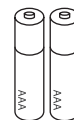

Batteries

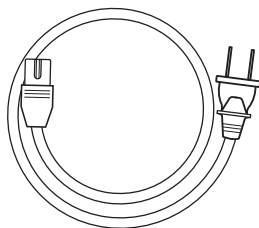

Main Power Cord

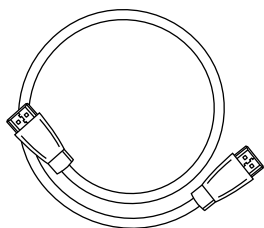

HDMI Cable

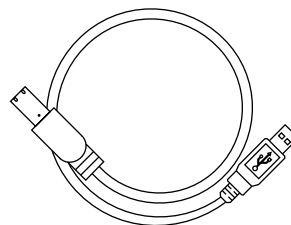

USB Cable (A to B)

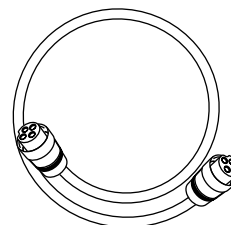

4M Speaker Cable

<p>Remote</p> <p>Télécommande Control remoto Fernbedienung Telecomando Control remoto 遥控器</p>	<p>Batteries</p> <p>Les Piles Pilas Batterien Baterias Batterie Batterie 電池</p>	<p>Main Power Cord</p> <p>Cordon d'alimentation principal Cordón principal de alimentación Hauptnetz kabel Cavo di alimentazione principale Cabo de alimentação principal 主电源线</p>	<p>HDMI Cable</p> <p>Câble HDMI Cable de HDMI HDMI-Kabel Cavo HDMI Cabo HDMI HDMI 電纜</p>	<p>USB Cable</p> <p>Câble USB Cable USB USB-Kabel Cavo USB Cabo USB USB 電纜</p>	<p>Speaker Wire</p> <p>Fil d'enceinte Cable de altavoz Lautsprecherkabel Cavo altoparlante Cabo para caixa acústica 音箱导线</p>
--	--	---	---	---	---

RIGHT SPEAKER (ACTIVE)

ENCEINTE DROITE (ACTIVE) • ALTAVOZ DERECHO (ACTIVO) • RECHTER LAUTSPRECHER (AKTIV) • ALTOPARLANTE DESTRO (ATTIVO) • CAIXA ACÚSTICA DIREITA (ATIVA) • 右音箱 (有源)

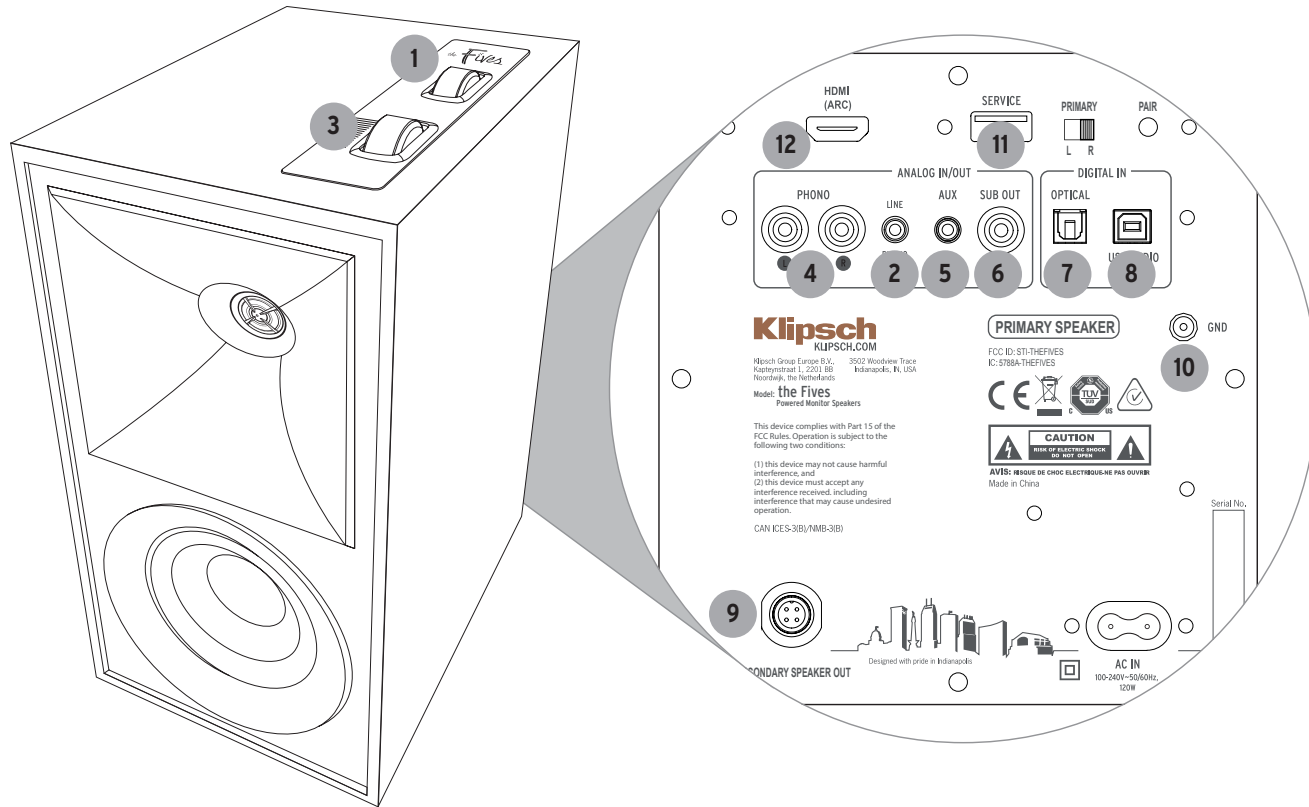

<p>1 LED Source Indicator Indicateur de source à DEL Indicador LED de fuente LED-Quellenanzeige Spia LED sorgente audio LED indicador de fonte LED 源指示灯</p>	<p>2 Phono/Line Switch Interrupteur Phono/Ligne Commutador de tocadiscos y línea Phono/Line-Schalter Selettore phono/linea Chave fono/linha 唱机/线路开关</p>	<p>3 Volume/Source Control Commande Volume/Source Control de volumen y fuente Regler Lautstärke/Quelle Comando volume/sorgente audio Controle de volume/fonte 音量/源控制</p>	<p>4 Phono Input Entrées phono Entradas de tocadiscos Phono-Eingänge Ingressi phono Entradas fono 唱机输入</p>	<p>5 Auxiliary 3.5mm Input Entrée auxiliaire de 3,5 m Entrada auxiliar de 3,5 mm 3,5-mm-AUX-Eingang Ingresso auxiliar da 3,5 mm Entrada auxiliar de 3,5 mm 辅助 3.5mm 输入</p>
--	--	---	---	---

<p>6 Subwoofer Output Sortie du haut-parleur d'extrêmes graves Salida de subwoofer Subwoofer-Ausgang Uscita subwoofer Saída para subwoofer 低音炮输出</p>	<p>7 Optical Input Connexion Optique Conexión Óptica Optische verbindung Conessione Óptica Conexão Ótica 数字光纤连接</p>	<p>8 USB Audio Input Entrée USB Entrada de audio USB USB-Audio-Eingang Ingresso audio USB Entrada de áudio USB USB 音频输入</p>	<p>9 Secondary Speaker Out Borne d'enceinte gauche Terminal de altavoz izquierdo Linker Lautsprecherterminal Terminale altoparlante sinistro Terminal da caixa acústica esquerda 左音箱端子</p>
---	--	--	---

<p>10 Ground Screw Terminal Borne de la vis de raccord à la terre Terminal de tornillo de conexión a tierra Erdungsanschluss Terminale a vite di messa a terra Terminal de parafuso terra 接地螺钉端子</p>	<p>11 Service Port Port de service Puerto de servicio Service-Port Porta di servizio Porta de serviço 服务端口</p>	<p>12 HDMI ARC HDMI ARC Arco HDMI HDMI ARC HDMI ARC HDMI ARC HDMI ARC</p>
---	---	--

SETUP

INSTALLATION • CONFIGURACIÓN • SETUP • INSTALLAZIONE • INSTALAÇÃO • 设置

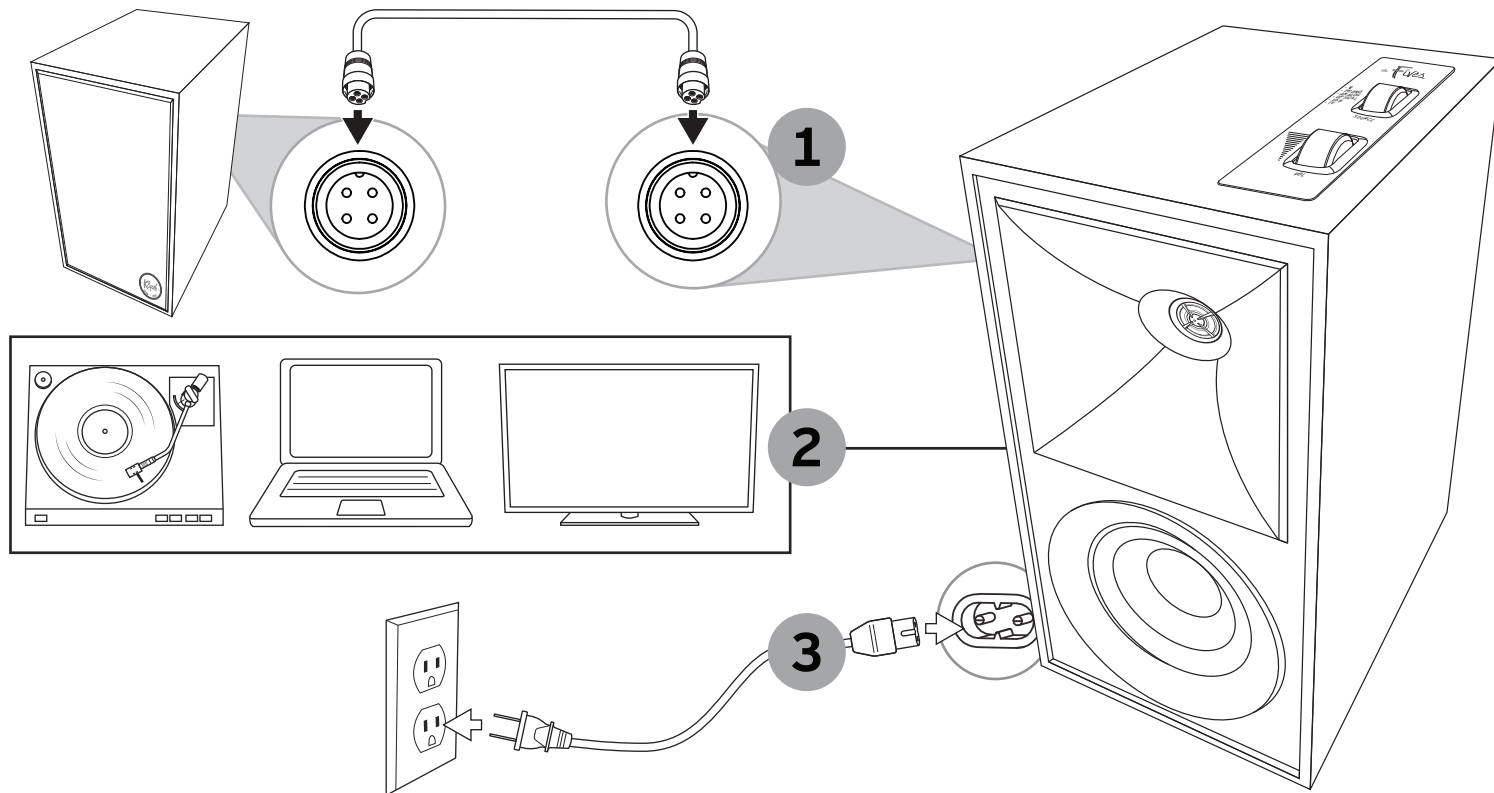

SELECT SOURCE

SELECTIONNER LA SOURCE • SELECCIÓN DE FUENTE • QUELLE WÄHLEN • SELEZIONE SORGENTE AUDIO • SELEÇÃO DA FONTE • 选择源

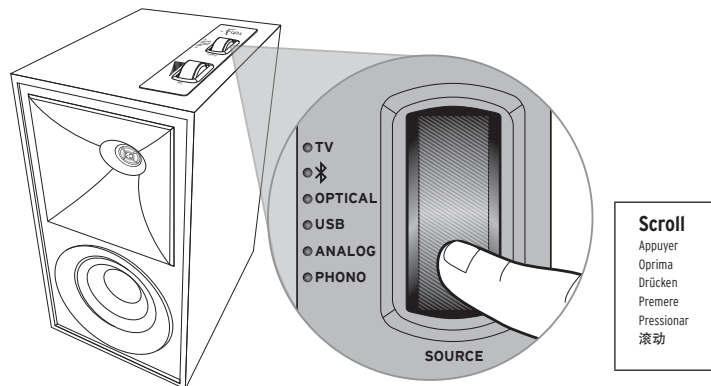

CARE AND CLEANING

ENTRETIEN ET NETTOYAGE • CUIDADO Y LIMPIEZA • PFLEGE UND REINIGUNG • CURA E PULIZIA • CUIDADOS E LIMPEZA • 保养与清洁

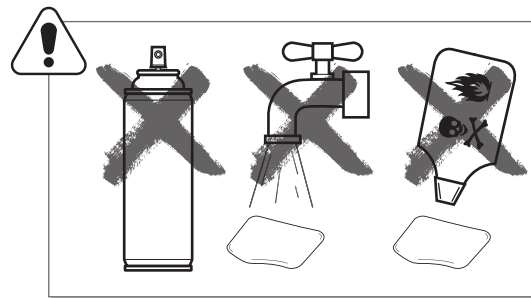
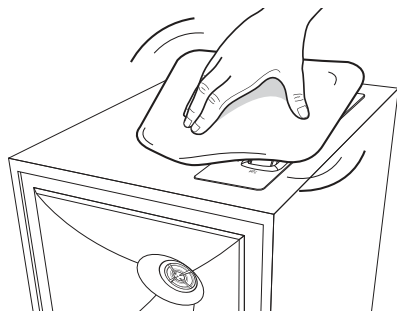

*** USE MICROFIBER CLOTHS ONLY**

*Utilisez des chiffons en microfibres seulement

*Use solamente paños de microfibra

*Nur Mikrofaserlätcher verwenden

*Usare solo panni in microfibra

*Use somente tecidos de microfibra

*仅限使用超细纤维布

CONNECTIONS - HDMI-ARC (IF TV HAS NO HDMI-ARC OUT SEE NEXT PAGE)

CONNEXIONS - HDMI-ARC • CONEXIONES - HDMI-ARC • ANSCHLÜSSE - HDMI-ARC • CONNESSIONI - HDMI-ARC • CONEXÕES - HDMI-ARC • 连接 - HDMI-ARC • (HDMI ARC (قناة عودة الصوت) HDMI ARC - التوصيلات

A Basic TV HDMI input will not transfer the TV audio signal to the Speakers. The Fives will only receive TV audio through HDMI-ARC (with CEC turned ON), Optical or Analog connection.

Une entrée TV HDMI de base ne transférera pas le signal audio TV vers altavoces. Les Fives ne recevra l'audio TV qu'au moyen d'une connexion HDMI-ARC (avec CEC sur MARCHÉ (ON)), Optique ou Analogique.

Una entrada básica de HDMI de una TV no transfiere la señal de audio de haut-parleurs. Les Fives solo recibirá el audio de la TV a través de una conexión óptica o análoga de tipo HDMI-ARC (con el CEC encendido).

Ein einfacher HDMI-Eingang kann das TV-Audiosignal nicht an der Lautsprecher übertragen. Die Fives kann das das TV-Audiosignal nur über HDMI-ARC (bei aktiviertem CEC), eine optische oder analoge Verbindung empfangen.

Il normale input televisivo HDMI non permette di trasmettere i segnali audio televisivi alla altoparlanti. La Fives riceve i segnali audio televisivi soltanto dai connettori HDMI-ARC (con CEC impostata su ON), ottici o analogici.

Uma entrada HDMI TV básica não transfere o sinal de áudio da TV para a alto-falante. Os Fives recebe áudio da TV somente através de uma conexão HDMI-ARC (com CEC ligado), óptica ou analógica.

一个基本的电视 HDMI 输入端不会将电视音频信号传送到声霸扬声器。The Fives 声霸扬声器只能通过 HDMI-ARC (CEC 打开状态下) 接收 电视音频、光学或类比信号。

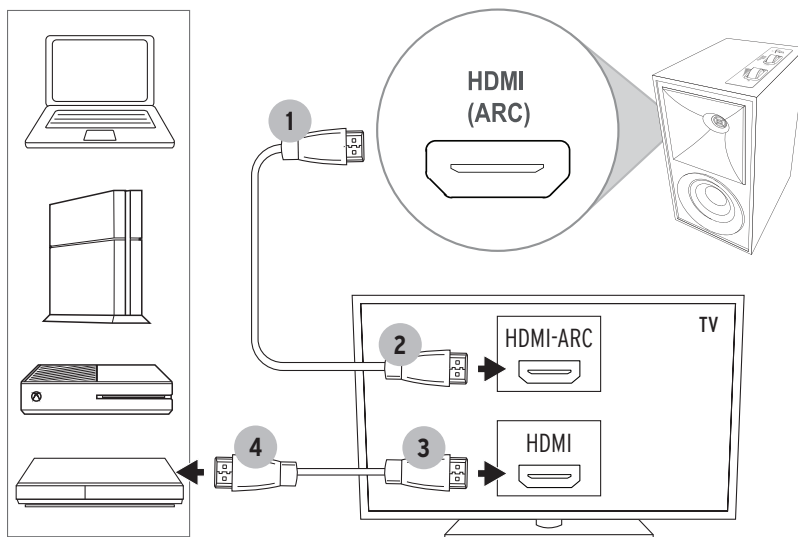

Si le téléviseur n'est pas équipé d'une sortie HDMI-ARC, reportez-vous à la page suivante

Si el televisor no tiene salida HDMI-ARC, vea la página siguiente

Wenn Fernseher nicht über einen HDMI-ARC-Ausgang verfügt, siehe nächste Seite

Se il televisore non ha un'uscita HDMI-ARC vedere alla pagina successiva

Se a TV não tiver saída HDMI-ARC, consulte a próxima página

如果电视没有 HDMI-ARC 输出，请参见下一页

CONNECTIONS - TV

CONNEXIONS - TV • CONEXIONES DEL TELEVISOR • ANSCHLÜSSE - TV • CONNESSIONI - TV • CONEXÕES - TV • 连接 - 电视

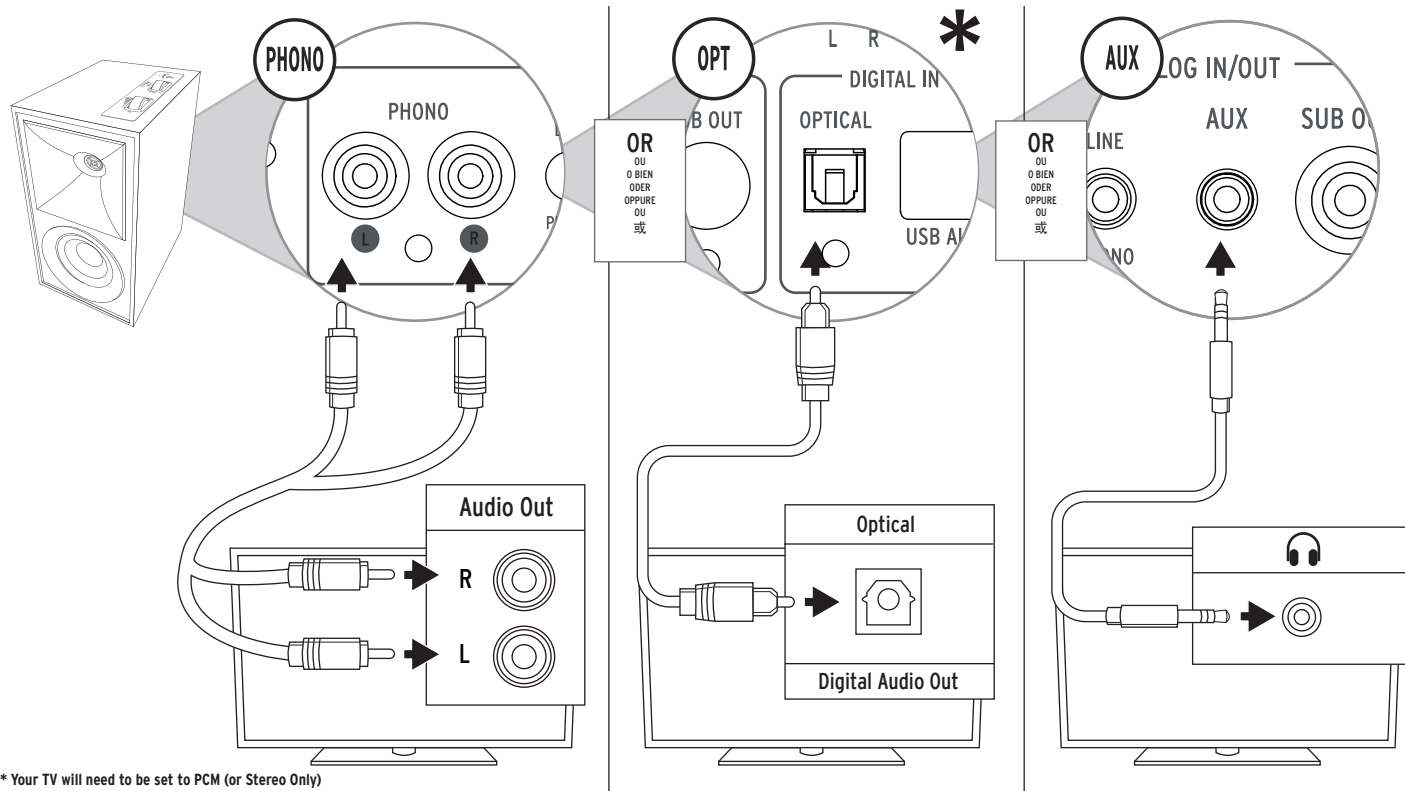

* Your TV will need to be set to PCM (or Stereo Only)

* Votre télévision devra être réglée sur la sortie MIC (Modulation d'impulsion codée) (ou stéréo seulement) * Su televisor debe fijarse en PCM (o Solo estéreo) * Ihr Fernseher muss auf PCM (oder Nur Stereo) eingestellt sein * Il televisore deve essere impostato su PCM (o solo stereo)

* A TV precisa ser configurada para PCM (ou apenas estéreo) * 需要将您的电视设置为 PCM (或仅设置为“立体声”)

CONNECTIONS - COMPUTER

CONNEXIONS - ORDINATEUR • CONEXIONES DE LA COMPUTADORA • ANSCHLÜSSE - COMPUTER • CONNESSIONI - COMPUTER • CONEXÕES - COMPUTADOR • 连接 - 计算机

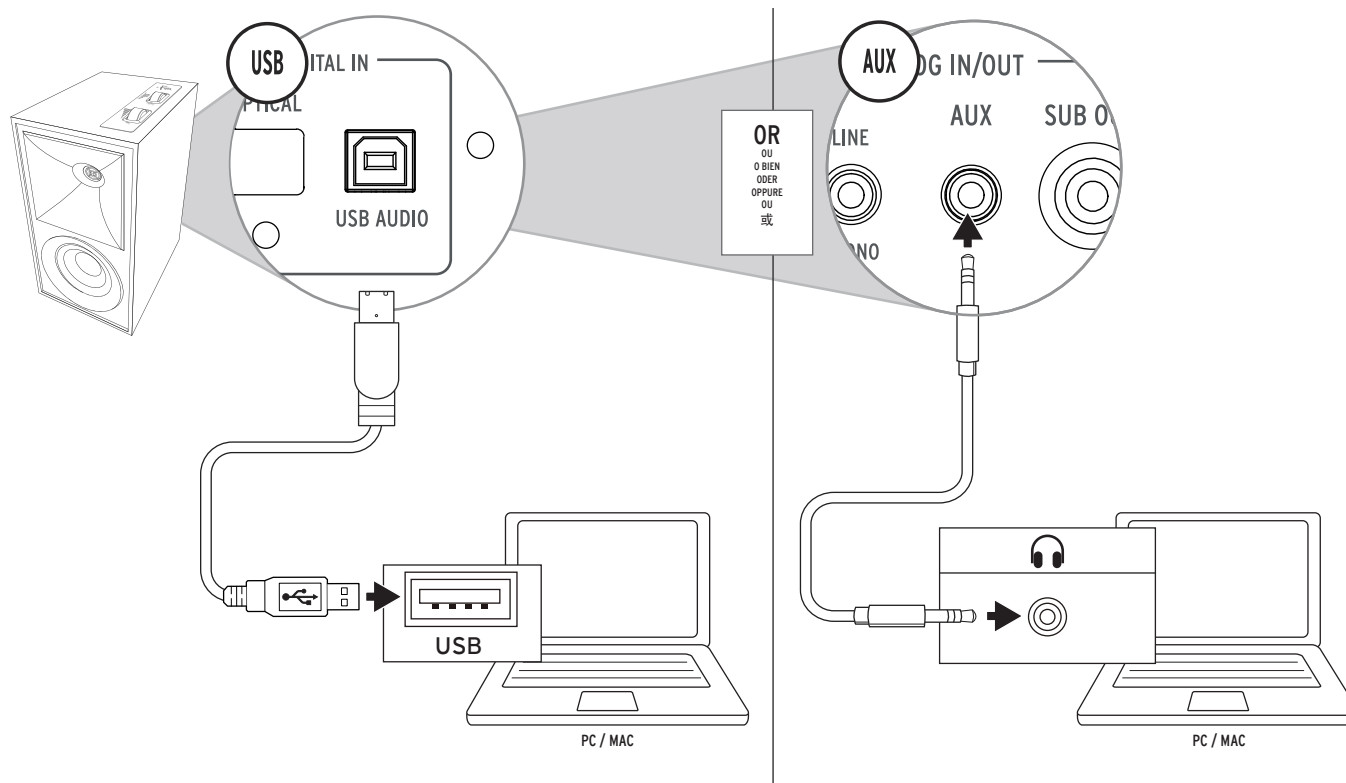

CONNECTIONS - TURNTABLE

CONNEXIONS - PLATINES • CONEXIONES DEL TOCADISCOS • ANSCHLÜSSE - PLATTENSPIELER • CONNESSIONI - GIRADISCHI • CONEXÕES - TOCA-DISCOS • 连接

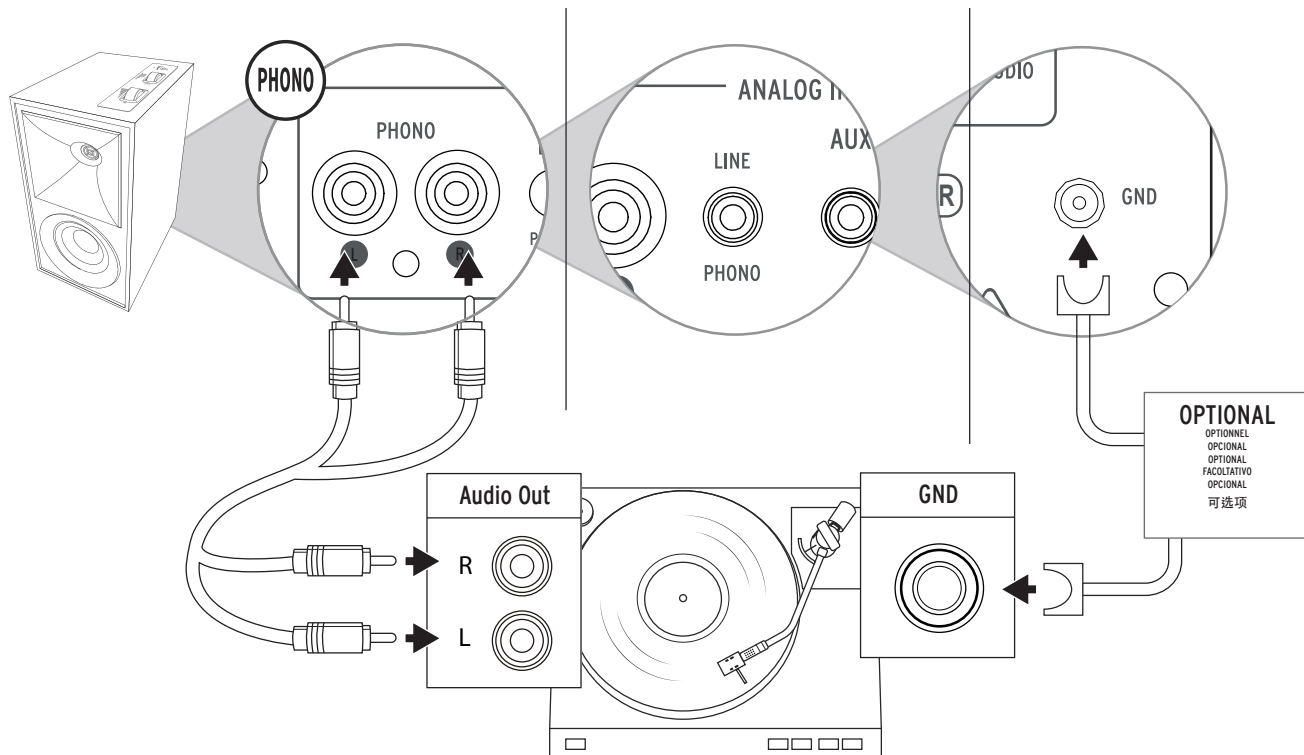

REMOTE

TÉLÉCOMMANDE • CONTROL REMOTO • FERNBEDIENUNG • TELECOMANDO • CONTROLE REMOTO • 遥控器

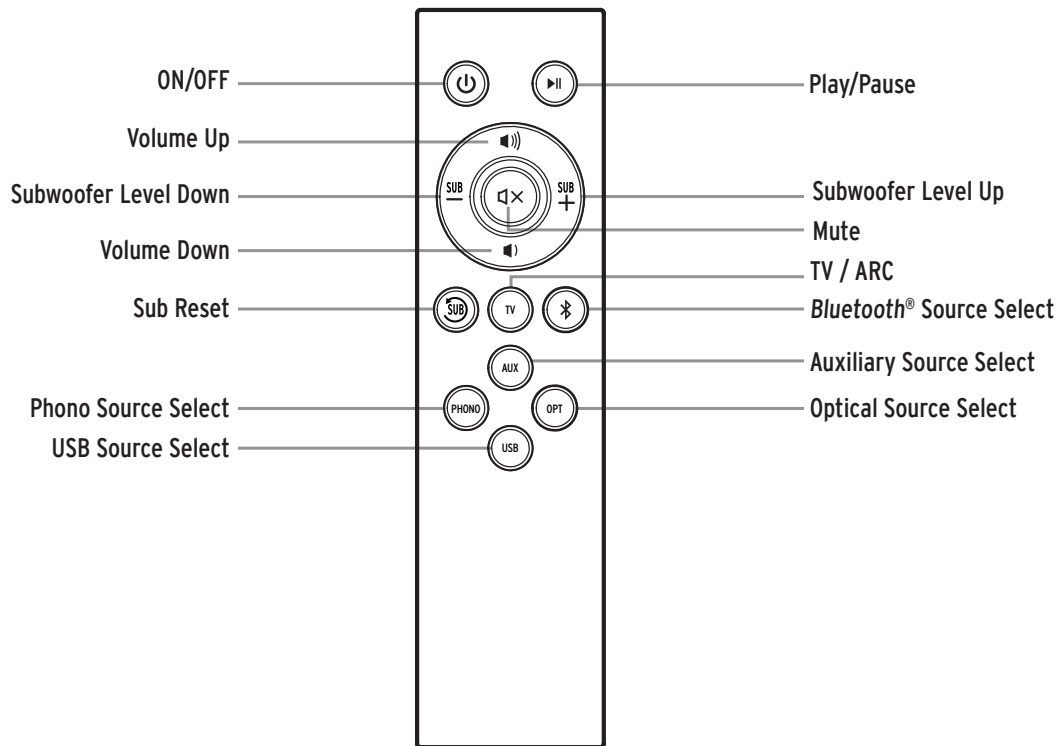

IR REMOTE CONTROL CODES

ON / OFF	0x 807F 1AE5
Mute	0x 807F 01FE
Subwoofer Level Up	0x 807F 07F8
Subwoofer Level Down	0x 807F 0AF5
Volume Up	0x 807F 03FC
Volume Down	0x 807F 06F9
TV / ARC	0x 807F 19E6
Subwoofer Level Reset	0x 807F 3EC1
Play/Pause	0x 807F 2IDE
Phono Source Select	0x 807F 0FF0
Auxiliary Source Select	0x 807F 0EF1
Digital Optical Source Select	0x 807F 0CF3
USB Source Select	0x 807F 12ED
Bluetooth® Source Select	0x 807F 0DF2

<p>ON / OFF Sous tension / Hors tension Encendido / Apagado Ein / Aus Acceso / Spento Ligar / Desligar 开/关</p>	<p>Mute Sourdine Silenciador Stummuschaltung Disattivazione audio Desativar áudio 静音</p>	<p>Subwoofer Level Up Niveau haut du haut-parleur d'extrêmes graves Subida de nivel de subwoofer Subwoofer-Pegel Plus Aumento livello subwoofer Aumentar nível de volume do subwoofer 低音炮电平上升</p>	<p>Subwoofer Level Down Niveau bas du haut-parleur d'extrêmes graves Bajada de nivel de subwoofer Subwoofer-Pegel Minus Riduzione livello subwoofer Diminuir nível de volume do subwoofer 低音炮电平下降</p>	<p>Volume Up Volume haut Subida de volumen Lauter Aumento volume Aumentar o volume 音量增大</p>	<p>Volume Down Volume bas Bajada de volumen Leiser Riduzione volume Diminuir o volume 音量减小</p>
---	---	--	--	--	---

<p>Subwoofer Level Reset Réinitialisation du niveau du haut-parleur d'extrêmes graves Restablecimiento de nivel de subwoofer Subwoofer-Pegel zurücksetzen Ripristino livello subwoofer Restabelecer nível de volume do subwoofer 低音炮电平复位</p>	<p>TV LA TÉLÉ TV FERNSEHER TV TELEVISÃO 电视</p>	<p>Play/Pause Lecture/pause Reproducción/pausa Wiedergabe/Pause Riproduzione / Pausa Reproduzir/Pausar 播放/暂停</p>
---	---	---

<p>Phono Source Select Sélection de la source Phono Selección de fuente de tocadiscos Phone-Quellenwahl Selezione sorgente phono Seleção de fonte fono 唱机源选择</p>	<p>Auxiliary Source Select Sélection de la source auxiliaire Selección de fuente auxiliar AUX-Quellenwahl Selezione sorgente ausiliaria Seleção de fonte auxiliar 辅助源选择</p>	<p>Digital Optical Source Select Sélection de la source optique numérique Selección de fuente óptica digital Digital-optische Quellenwahl Selezione segnale ottico digitale Seleção de fonte ótica digital 数字光学源选择</p>	<p>USB Source Select Sélection de la source USB Selección de fuente USB USB-Quellenwahl Selezione sorgente USB Seleção de fonte USB USB 源选择</p>	<p>Bluetooth® Source Select Sélection de la source Bluetooth® Selección de fuente Bluetooth® Bluetooth®-Quellenwahl Selezione segnale Bluetooth® Seleção de fonte Bluetooth® 蓝牙源选择</p>
---	--	---	--	---

BLUETOOTH® WIRELESS TECHNOLOGY

TECNOLOGÍA INALÁMBRICA **BLUETOOTH®** • CONFIGURACIÓN DE TECNOLOGÍA WIRELESS **BLUETOOTH®** • DRAHTLOSE **BLUETOOTH®**-TECHNOLOGIE-SETUP • CONFIGURAZIONE TECNOLOGIA WIRELESS **BLUETOOTH®** • CONFIGURAÇÃO DE TECNOLOGIA SEM FIO **BLUETOOTH®** • **BLUETOOTH®** 蓝牙无线电子技术

PAIR

CONNEXION
CONEXIÓN
VERBINDEN
COLLEGAMENTO
CONNECTAR
连接

1

Hold 3 Seconds

Appuyer pendant 3 secondes
Mantenga oprimido durante 3 segundos
3 Sekunden gedrückt halten
Tenere premuto per 3 secondi
Manter pressionado por 3 segundos
保持 3 秒

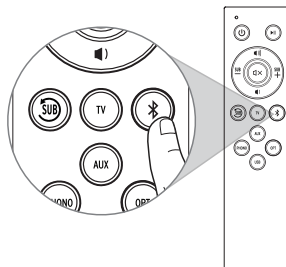

OR

OU
O BIEN
ODER
OPPURE
OU
或

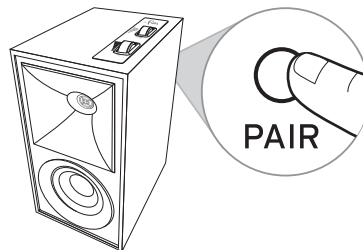

2 Flashing

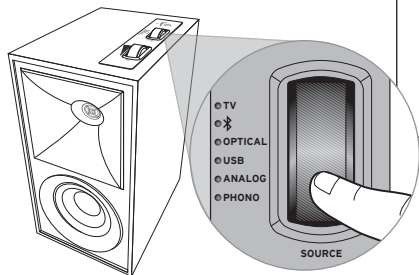

Flashing

Clignotant
Destello
Blinkt
Lampeggiante
Intermittente
闪烁

3

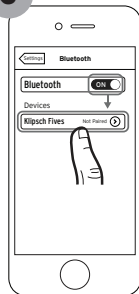

4

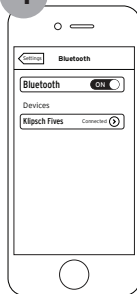

5 Solid

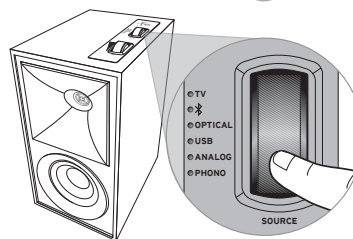

Solid

Continu
Continuo
Dauerhaft
Luce fissa
Constante
常亮

Example only. Your device may differ.

• À titre d'exemple seulement. Votre appareil peut être différent. • Este es solo un ejemplo. Es posible que su dispositivo sea diferente. • Nur als Beispiel. Ihr Gerät kann anders aussehen
• Solo a titolo esemplificativo. Lo specifico dispositivo può essere diverso. • Apenas para exemplo. O dispositivo pode ser diferente. • 仅为示例。实际设备可能有所不同

RECONNECT

RECONNECTER
RECONNECTAR
ERNEUT VERBINDEN
RICONNESSIONE
RECONNECTAR
重新连接

1

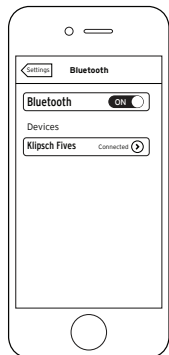

2 Press x1

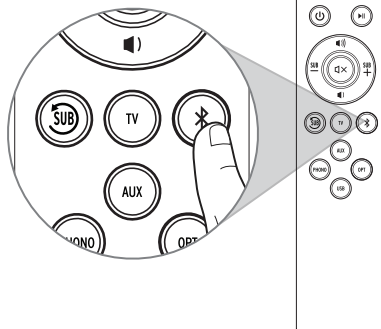

Press x1

Appuyer 1 fois
Oprima 1 vez
Ix drücken
Premere 1 volta
Pressionar uma vez
按 1 次

3 Solid

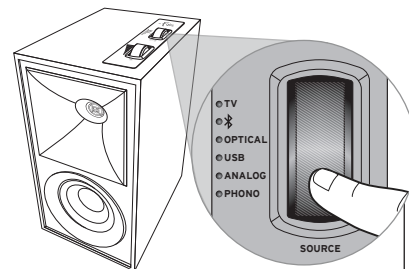

Solid

Continu
Continuo
Dauerhaft
Luce fissa
Constante
常亮

SUBWOOFER OUTPUT

SORTIE DU HAUT-PARLEUR D'EXTRÊMES GRAVES • SALIDA DE SUBWOOFER • SUBWOOFER-AUSGANG • USCITA SUBWOOFER • SAÍDA PARA SUBWOOFER • 低音炮输出

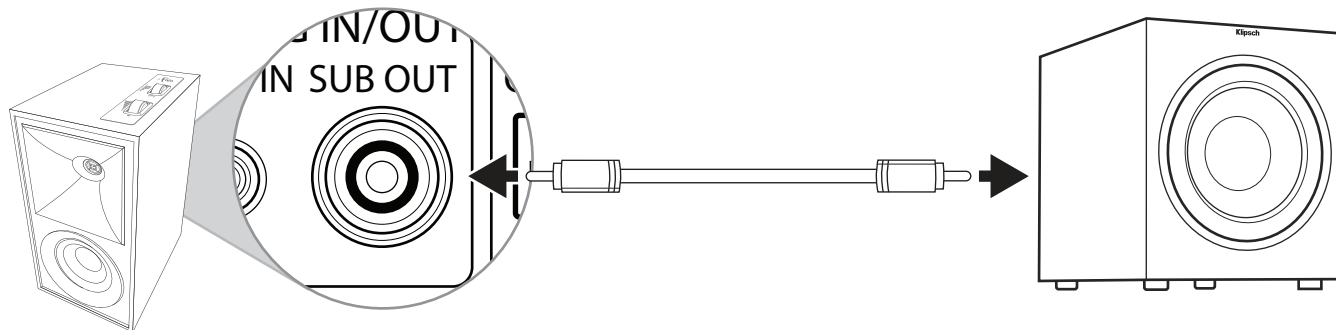

LED SOURCE INDICATOR

INDICATEUR DE SOURCE À DEL • INDICADOR LED DE FUENTE • LED-QUELLENANZEIGE • SPIA LED SORGENTE AUDIO • LED INDICADOR DE FONTE • LED 源指示灯

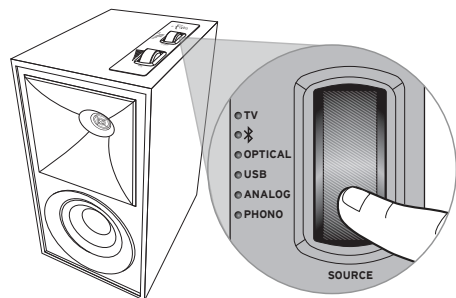

<p>Bluetooth® Input Entrée Bluetooth® Entrada Bluetooth® Bluetooth®-Eingang Ingresso Bluetooth® Entrada Bluetooth® LED 源指示灯</p>	<p>Phono Input Entrée phono Entrada de tocadiscos Phono-Eingang Ingresso phono Entrada fono 唱机输入</p>	<p>Auxiliary Input Entrée auxiliaire Entrada auxiliar AUX-Eingang Ingresso auxiliar Entrada auxiliar 辅助输入</p>
<p>Optical Input Connexion Optique Conexión Óptica Optische Verbindung Connessione Ottica Conexão Ótica 数字光纤连接</p>	<p>USB Audio Input Entrée audio USB Entrada de audio USB USB-Audio-Eingang Ingresso audio USB Entrada de áudio USB USB 音频输入</p>	<p>TV La télé TV Fernseher TV Televisão 电视</p>

DYNAMIC BASS EQ

ÉGALISATION DYNAMIQUE DES BASSES • ECUALIZACIÓN DE BAJOS DINÁMICOS • DYNAMISCHER BASS-EQ • EQUALIZZAZIONE DEI BASSI DINAMICA • EQUALIZAÇÃO DINÂMICA DE GRAVES • 动态低音均衡

Dynamic Bass EQ applies loudness correction to automatically adjust low frequency levels as volume changes.

L'égalisation dynamique des graves applique une correction du volume sonore pour régler automatiquement le niveau des basses fréquences au fur et à mesure des variations de volume.

La ecualización de bajos dinámicos corrige la sonoridad para ajustar automáticamente los niveles de las frecuencias bajas según los cambios de volumen.

Der Dynamische Bass-EQ setzt eine Lautstärkeregelung ein, um bei Lautstärkeänderungen die Tieffrequenzpegel automatisch anzupassen.

L'equalizzazione dei bassi dinamica applica la correzione della sonorità per regolare automaticamente i livelli a bassa frequenza in funzione delle variazioni del volume.

A equalização dinâmica de graves aplica correção de intensidade para ajustar automaticamente os níveis de baixa frequência quando há mudança no volume.

动态低音均衡器应用响度校正功能，随音量变化自动调节低音电平。

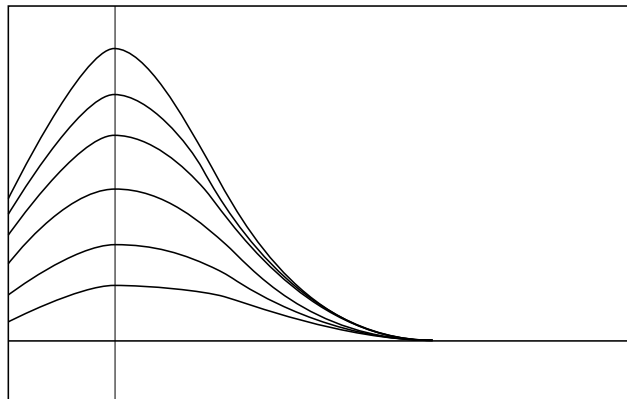

For best results, increase input source volume to maximum.

Pour de meilleurs résultats, augmentez au maximum le volume de la source d'entrée.

Para obtener resultados óptimos, aumente el volumen de la fuente de entrada al máximo.

Steigern Sie am besten die Lautstärke der Eingangsquelle aufs Maximum.

Per ottenere risultati ottimali, aumentare al massimo il volume della sorgente audio.

Para obter melhores resultados, aumente o volume da fonte de entrada para o máximo.

为获得最佳效果，请将输入音量增加到最大。

DISABLE / ENABLE DYNAMIC BASS EQ

DÉSACTIVER/ACTIVER L'ÉGALISEUR DES GRAVES DYNAMIQUE • DESACTIVAR / ACTIVAR LA EQUALIZACIÓN DE BAJOS DINÁMICOS • DYNAMISCHEN BASS-EQ DEAKTIVIEREN/AKTIVIEREN • ABILITA / DISABILITA EQUALIZZAZIONE DEI BASSI DINAMICA • DESATIVAR/ ATIVAR A EQUALIZAÇÃO DINÂMICA DE GRAVES • 禁用/启用动态低音均衡器

1
Hold 3 Seconds
 Appuyer pendant 3 secondes
 Mantenga oprimido durante 3 segundos
 3 Sekunden gedrückt halten
 Tenere premuto per 3 secondi
 Manter pressionado por 3 segundos
 保持 3 秒

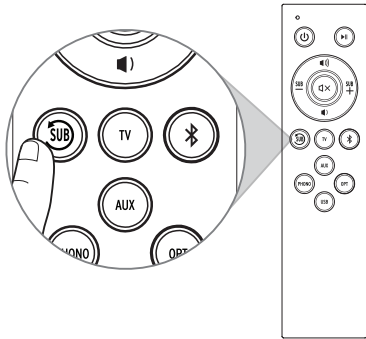

2
Flashes x2
 Clignote x2
 Destella x2
 Blinkt x2
 Lampeggia x2
 Piscará x2
 闪烁 x2

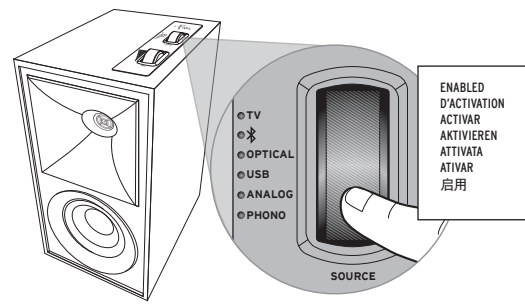

1
Hold 3 Seconds
 Appuyer pendant 3 secondes
 Mantenga oprimido durante 3 segundos
 3 Sekunden gedrückt halten
 Tenere premuto per 3 secondi
 Manter pressionado por 3 segundos
 保持 3 秒

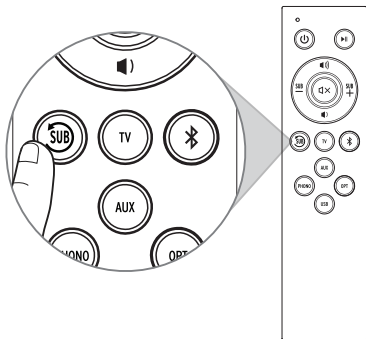

2
Flashes x1
 Clignote x1
 Destella x1
 Blinkt x1
 Lampeggia x1
 Piscará x1
 闪烁 x1

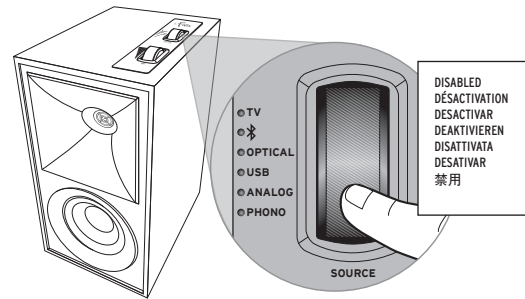

FACTORY RESET

RÉINITIALISATION • RESTABLECIMIENTO DE FÁBRICA • RÜCKSETZUNG AUF WERKSEINSTELLUNG • RIPRISTINO IMPOSTAZIONI DI FABBRICA • RESTABELECIMENTO DAS CONFIGURAÇÕES DE FÁBRICA • 恢复出厂设置

1 Select Source to Phono, Analog, Digital or USB

Sélectionner la source Phono, auxiliaire, Optique ou USB
Seleccionar tocadiscos, auxiliar, Óptica o bien USB
Quellenwahl auf Phono, AUX, Optische oder USB
Selezionare il segnale per phono, ausiliaria, Ottica oppure USB
Selecione a fonte para o fono, auxiliar, Ótica ou USB
选择源至唱机, 辅, 数字或USB

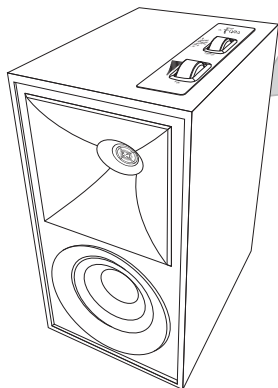

2

Press and Hold

Appuyer et Maintenir
Presione y mantenga
Drücken und halten
Tieni premuto
Pressione e segure
按下并保持

3

Press

Appuyer
Oprima
drücken
Premere
Pressionar
按

4

Release

Libération
Lanzamiento
Freisetzung
Liberare
Lançamento
发布

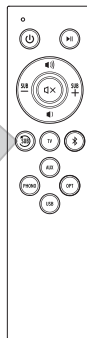
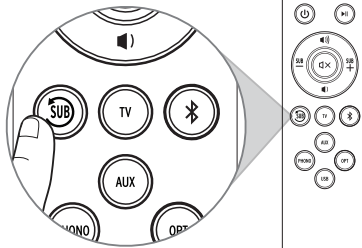

5 Flashes 10 Seconds

Clignote 10 secondes
Destella 10 segundos
10 Sekunden Blinkt
Lampeggia 10 secondi
Piscará 10 segundos
闪烁 10 秒

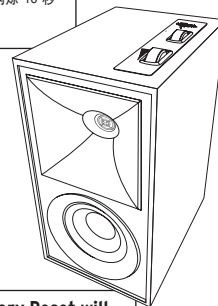

NOTE Factory Reset will clear the Bluetooth® pairing history

REMARQUE La réinitialisation aux réglages d'usine effacera l'historique d'association Bluetooth®
NOTA El restablecimiento de fábrica borra el historial de vinculación de Bluetooth®
HINWEIS Rücksetzung auf Werkseinstellungen löscht die gespeicherten Bluetooth®-Kopplungen
NOTA Il ripristino delle impostazioni di fabbrica cancella la cronologia delle associazioni Bluetooth®
OBSERVAÇÃO O restablecimento das configurações de fábrica apagará o histórico de emparelhamento Bluetooth®
注: 出厂设置恢复将清除蓝牙配对历史

REMOTE CONTROL CODES (FOR UNIVERSAL OR CABLE REMOTES)

RCA*	41609 OR 43915
DIRECTV	31609
XFINITY**	30531 OR 31023
BRIGHT HOUSE	288
AT&T (SILVER)	5156 OR 5023
AT&T (BLACK)	5156

* MUST HAVE AUDIO/AUX BUTTON OR AUDIO-SB BUTTON

** RED CENTER BUTTON

NOTE: NOT ALL UNIVERSAL REMOTES ARE COMPATIBLE

HEX CODES - SET 1	
VOLUME UP	0x 856A 9F60
VOLUME DOWN	0x 856A 9E61
MUTE	0x 856A 9966

HEX CODES - SET 3	
VOLUME UP	0x A55A 0AF5
VOLUME DOWN	0x A55A 0BF4
MUTE	0x A55A 12ED

HEX CODES - SET 4	
VOLUME UP	0x 859A 817E
VOLUME DOWN	0x 859A 827D
MUTE	0x 859A 8778

TROUBLESHOOTING

DÉPANNAGE • DETECCIÓN • HINWEISE ZUR PROBLEMBEHEBUNG • SOLUZIONE DEI PROBLEMI • SOLUCIONAR PROBLEMAS • 故障排除

Klipsch[®]

KEEPERS OF THE SOUND[™]