

PROMEDIA HERITAGE 2.1

Klipsch®

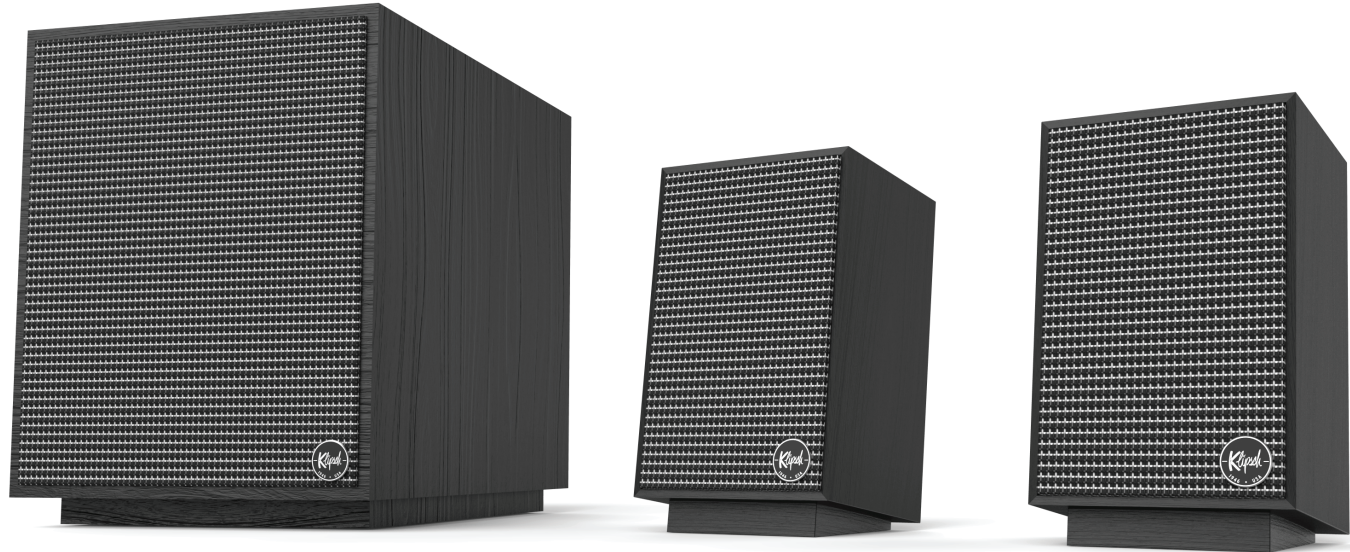

INSIDE

CONTENU • CONTENIDO • INHALT • CONTENUTO • CONT EÚDO • 目录 • 同梱品

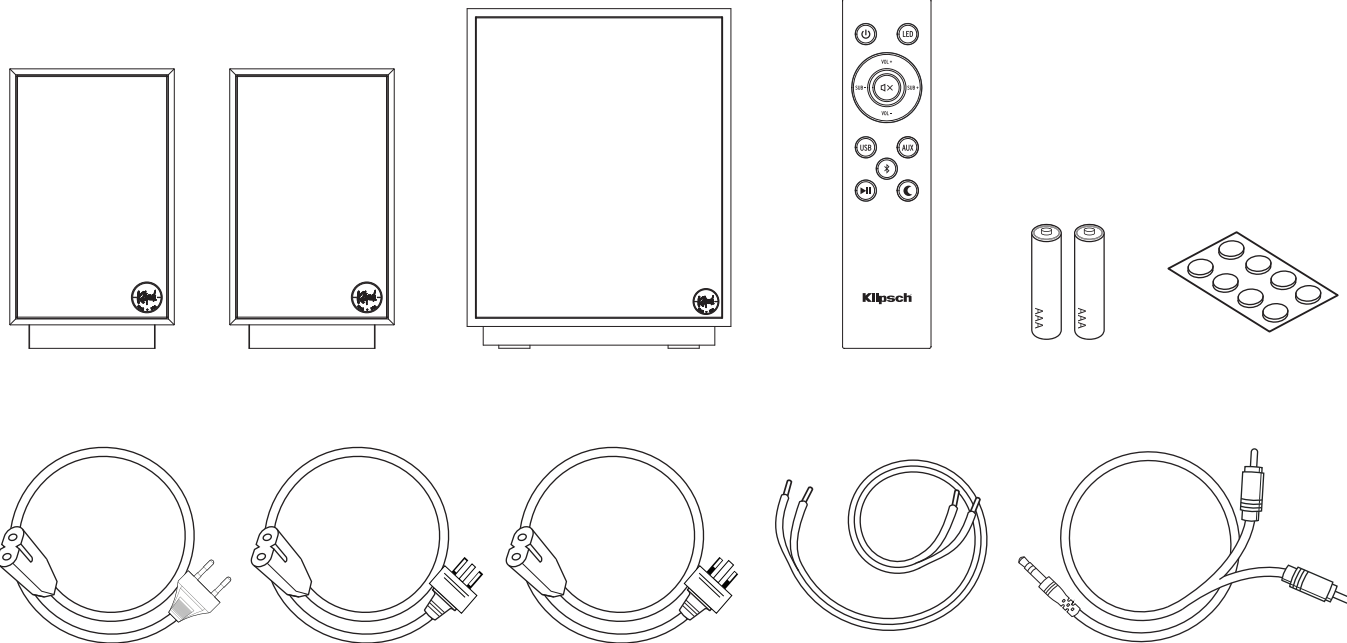

SPEAKER PLACEMENT

POSITIONNEMENT • UBICACIÓN • PLATZIERUNG • COLLOCAZIONE • POSICIONAMENTO • 放置

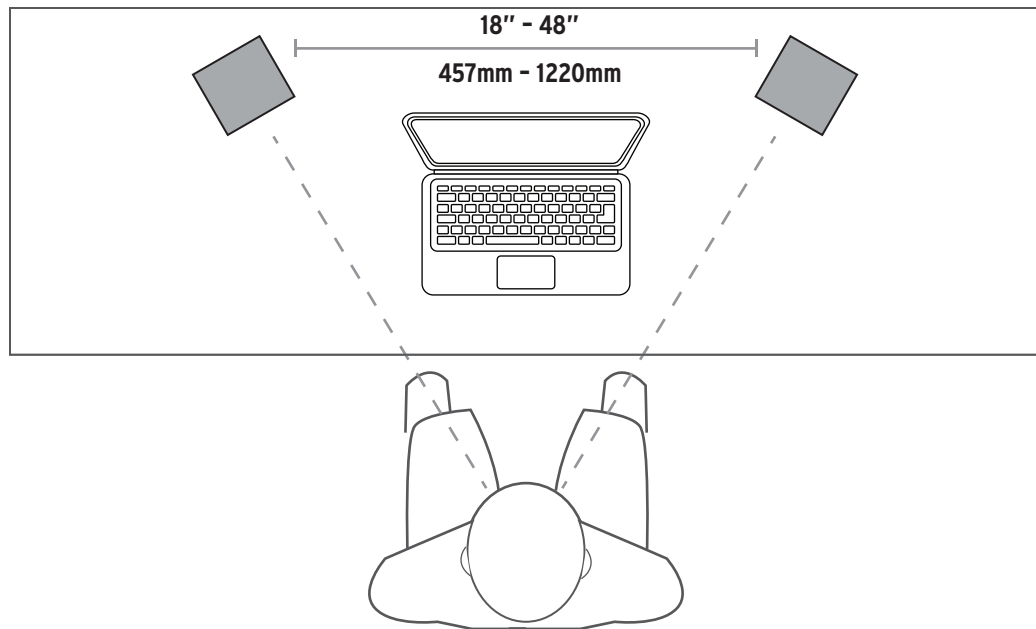

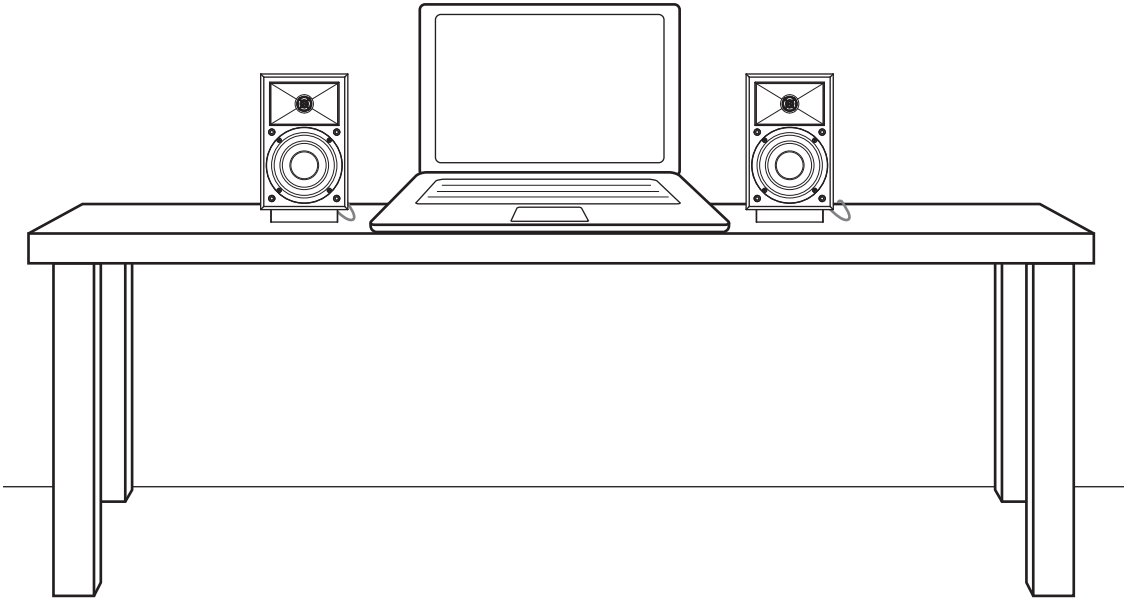

SUBWOOFER PLACEMENT

POSITIONNEMENT • UBICACIÓN • PLATZIERUNG • COLLOCAZIONE • POSICIONAMENTO • 放置

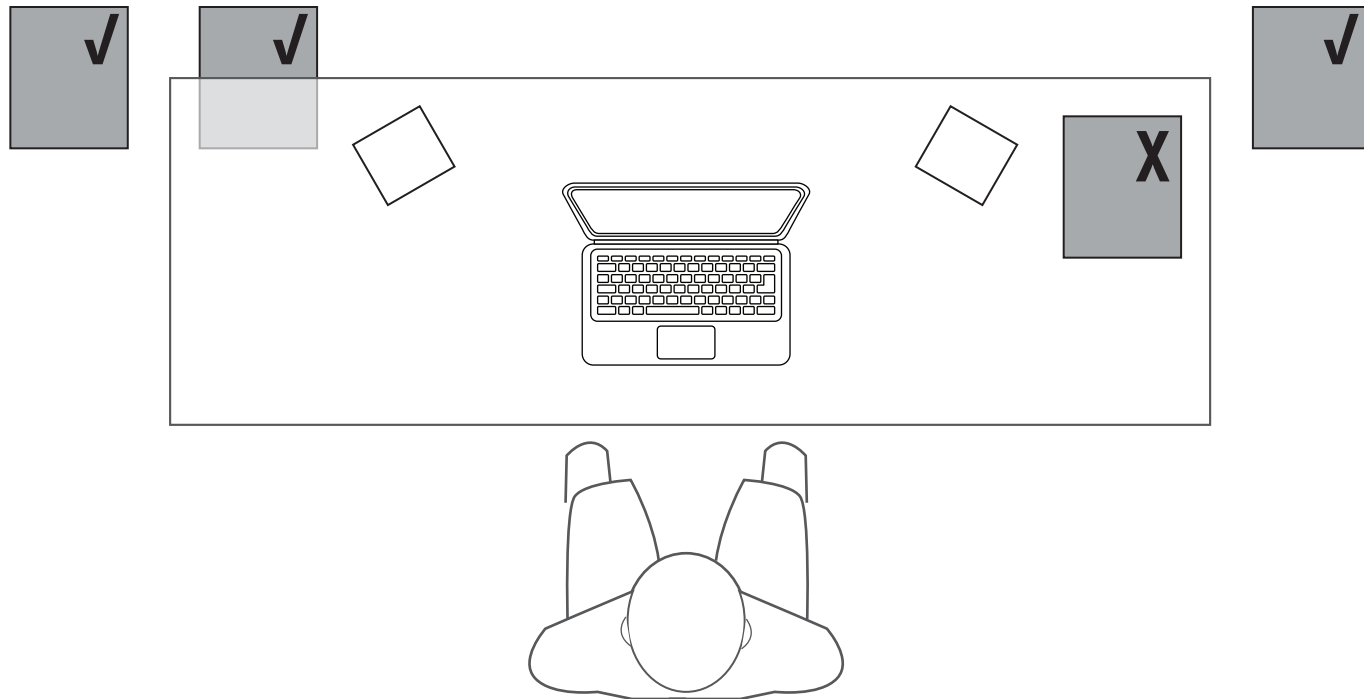

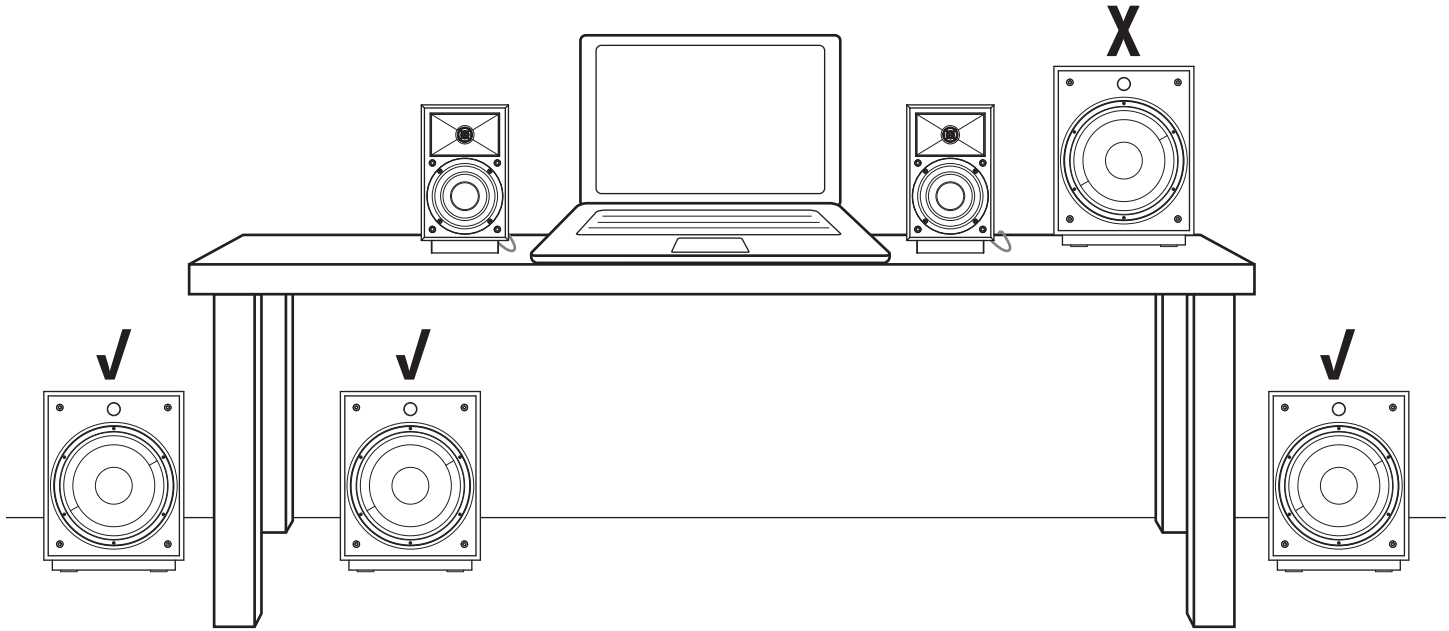

REMOTE

TÉLÉCOMMANDE • CONTROL REMOTO • FERNBEDIENUNG • TELECOMANDO • CONTROLE REMOTO • 遥控器 • リモート

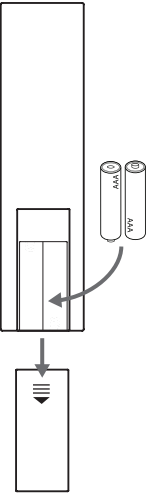
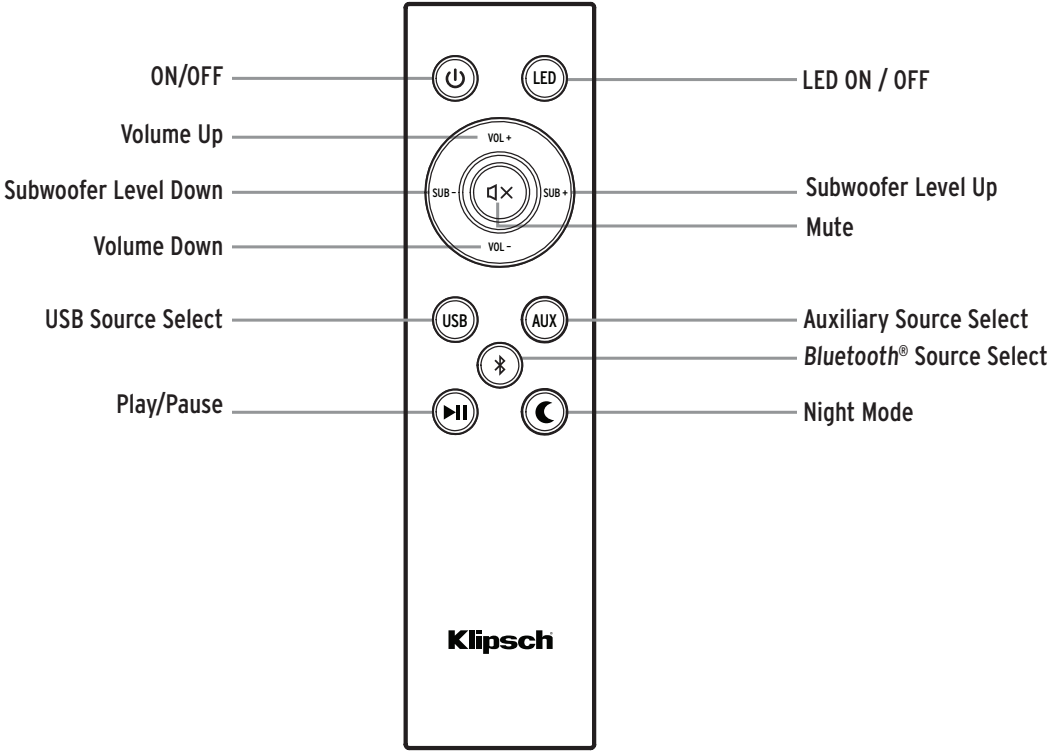

<p>ON / OFF</p> <p>Sous tension / Hors tension Encendido / Apagado Ein / Aus Acceso / Spento Ligar / Desligar 开/关 オン/オフ</p>	<p>LED ON / OFF</p> <p>DEL Sous tensio / Hors tensio LED Encendido / Apagado LED Ein / Aus LED Acceso / Spento LED Ligar / Desligar LED 开/关</p>	<p>Mute</p> <p>Sourdine Silenciador Stummschaltung Disattivazione audio Desativar áudio 静音 無音</p>	<p>Night Mode</p> <p>Mode nocturne Modalidad nocturna Nachtmodus Modalità notturna Modo notturno 夜间模式</p>
--	--	--	--

<p>Subwoofer Level Up</p> <p>Augmenter le son du caisson de basses Subida de nivel de subwoofer Subwoofer-Pegel Plus Aumento livello subwoofer Aumentar nível de volume do subwoofer 低音炮电平上升 サブウーファーレベルアップ</p>	<p>Subwoofer Level Down</p> <p>Baisser le son du caisson de basses Bajada de nivel de subwoofer Subwoofer-Pegel Minus Riduzione livello subwoofer Diminuir nível de volume do subwoofer 低音炮电平下降 サブウーファーレベルダウン</p>	<p>Volume Up</p> <p>Volume haut Subida de volumen Lauter Aumento volume Aumentar o volume 音量增大 音量アップ</p>	<p>Volume Down</p> <p>Volume bas Bajada de volumen Leiser Riduzione volume Diminuir o volume 音量减小 音量ダウン</p>
---	--	---	--

<p>USB Source Select</p> <p>Sélection de la source USB Selección de fuente USB USB-Quellenwahl Selezione sorgente USB Seleção de fonte USB USB 源选择 USBソース選択</p>	<p>Auxiliary Source Select</p> <p>Sélection de la source auxiliaire Selección de fuente auxiliar AUX-Quellenwahl Selezione sorgente ausiliaria Seleção de fonte auxiliar 補助源选择 補助ソース選択</p>	<p>Bluetooth® Source Select</p> <p>Sélection de la source Bluetooth® Selección de fuente Bluetooth® Bluetooth®-Quellenwahl Selezione segnale Bluetooth® Seleção de fonte Bluetooth® 蓝牙源选择 Bluetooth®ソース選択</p>	<p>Play/Pause</p> <p>Lecture/pause Reproducción/pausa Wiedergabe/Pause Riproduzione / Pausa Reproduzir/Pausar 播放/暂停 再生/停止</p>
--	---	--	--

SETUP

INSTALLATION • CONFIGURACIÓN • SETUP • INSTALLAZIONE • INSTALAÇÃO • 設置 • 設定

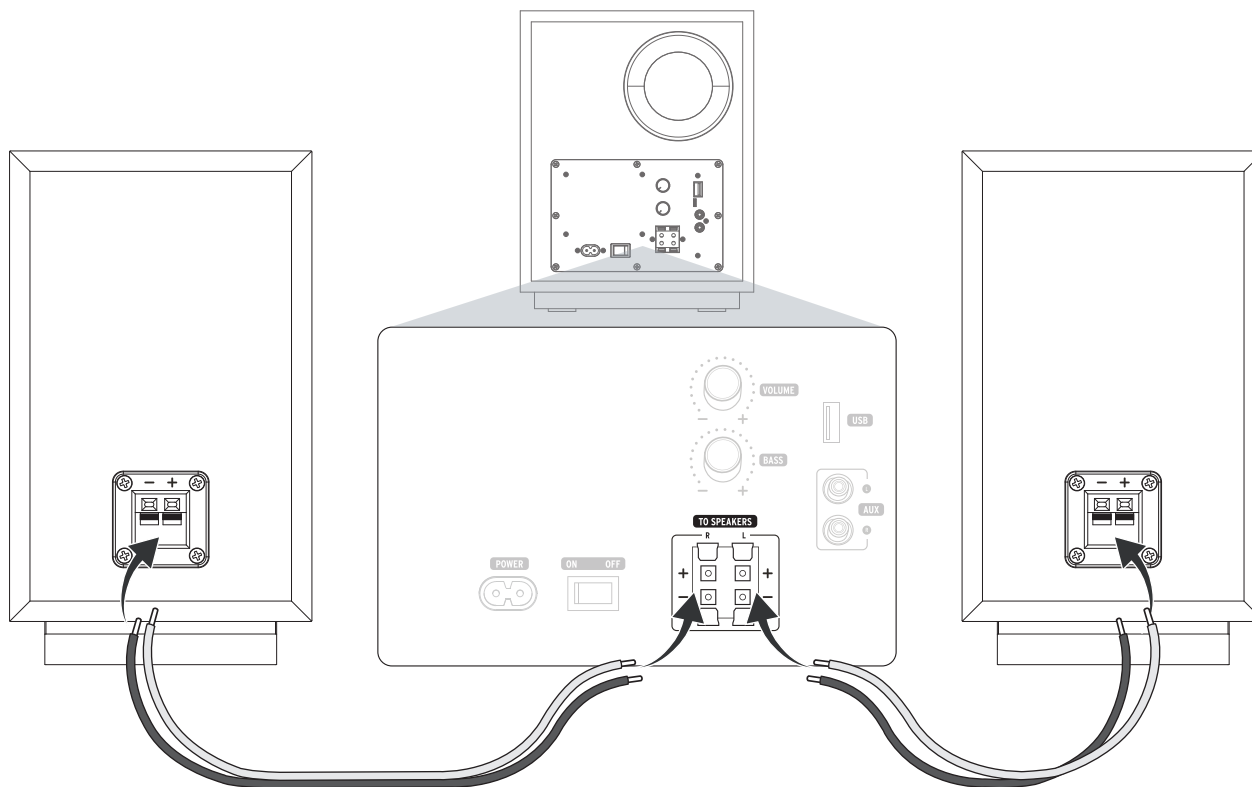

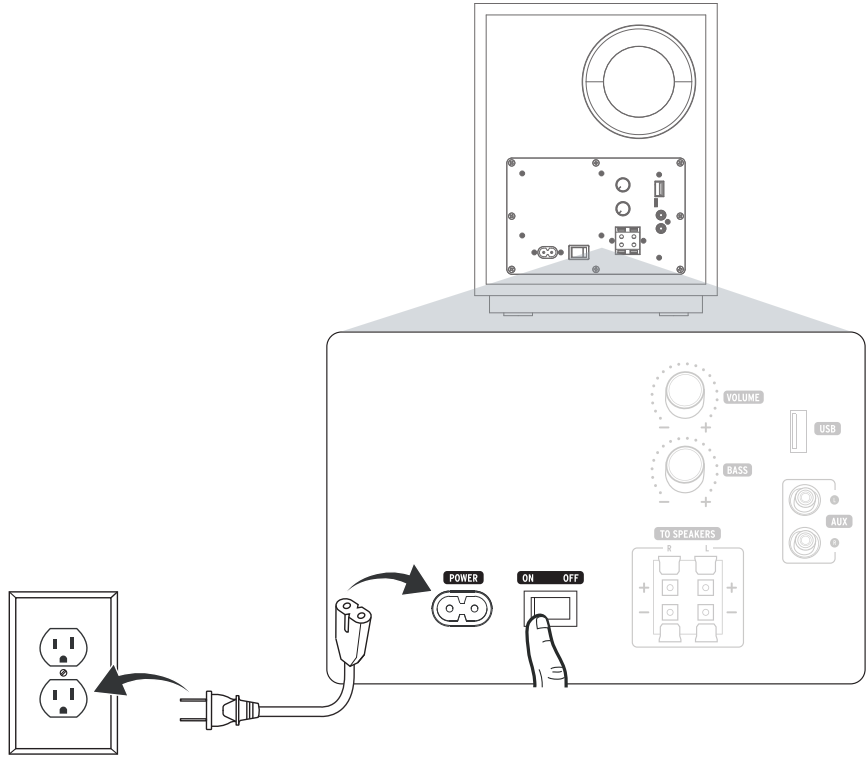

BLUETOOTH® WIRELESS TECHNOLOGY

TECNOLOGÍA INALÁMBRICA *BLUETOOTH*® • CONFIGURACIÓN DE TECNOLOGÍA WIRELESS *BLUETOOTH*® • DRAHTLOSE *BLUETOOTH*®-TECHNOLOGIE-SETUP • CONFIGURAZIONE TECNOLOGIA WIRELESS *BLUETOOTH*® • CONFIGURAÇÃO DE TECNOLOGIA SEM FIO *BLUETOOTH*® • *BLUETOOTH*® 蓝牙无线电子技术 • ソースコントロールダイヤル

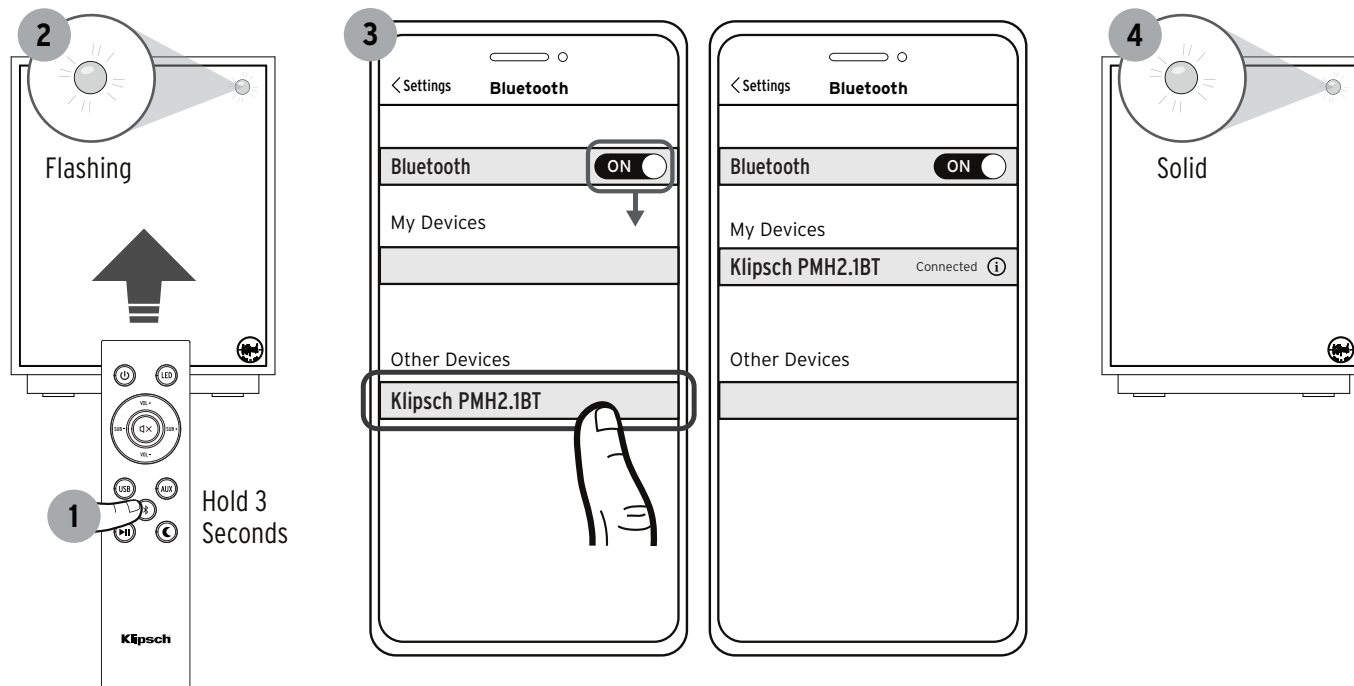

CONNECTIONS

CONNECTIONS • UBICACIÓN • ANSCHLÜSSE • CONNESSIONI • CONEXÕES • 连接

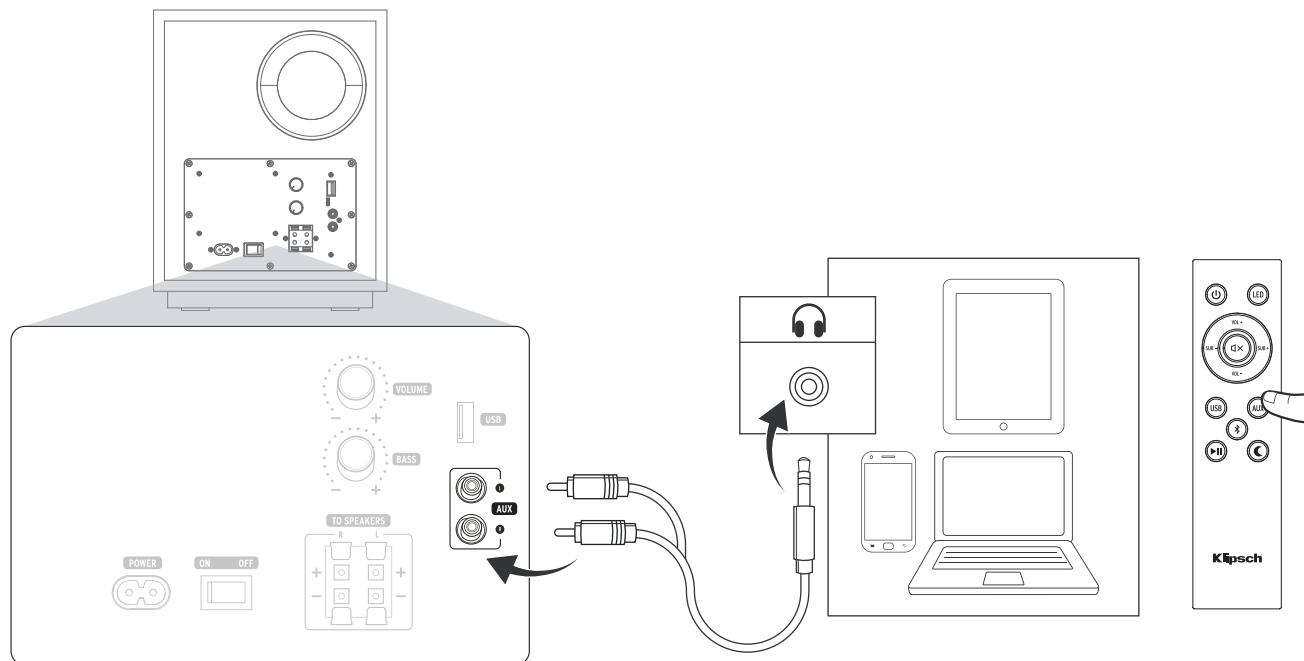

USB LISTENING

ÉCOUTE PAR USB • AUDICIÓN POR USB • HÖREN MIT USB • ASCOLTO TRAMITE USB • OUVIR PELO USB • 已选择 USB 输入

MP3	✓
WMA	X
AAC	X
WAV	X
AIFF	X
FLAC	X

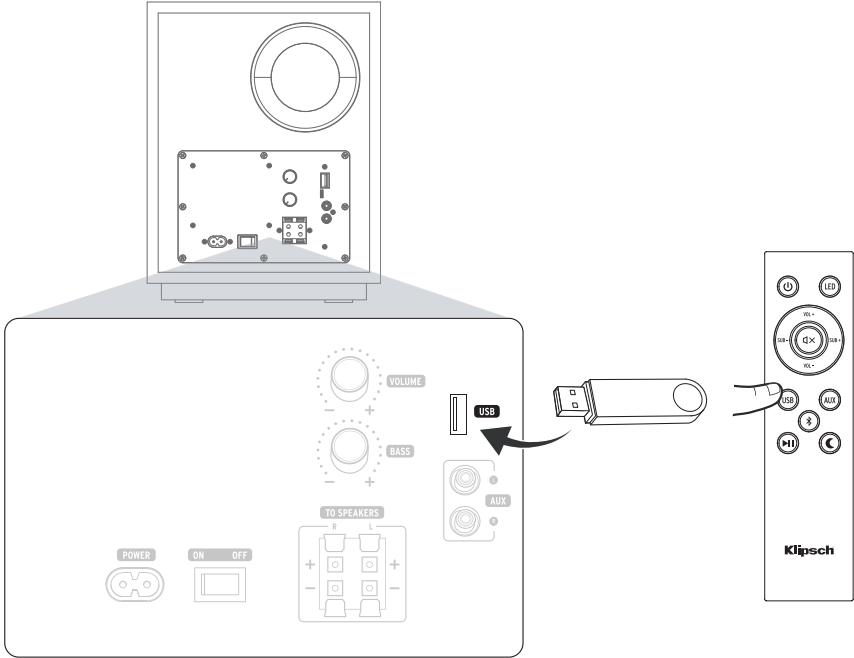

NIGHT MODE

MODE NOCTURNE • MODALIDAD NOCTURNA • NACHTMODUS • MODALITÀ NOTTURNA • MODO NOTURNO • 夜间模式

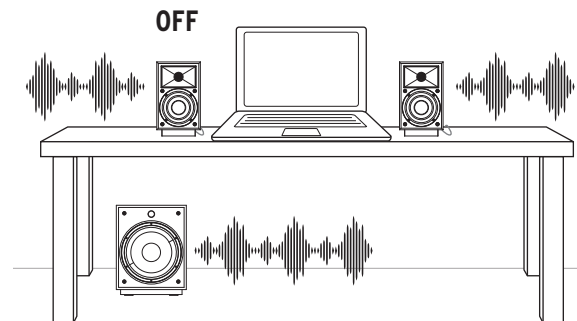
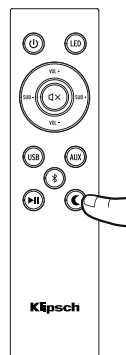
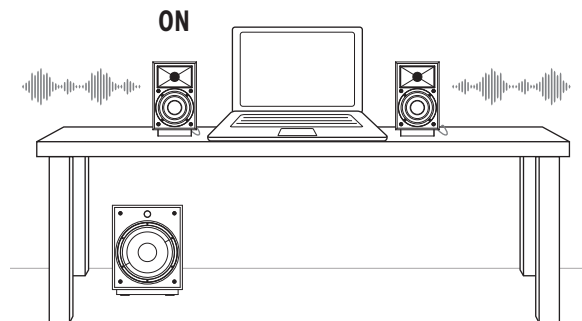

- Reduces Dynamic Range
- Subwoofer OFF
- Can be ON regardless of Dolby Status or Virtual Surround Mode
- Only one EQ profile active at one time (Standard, Dialog Enhanced, or Night)

- Réduit la gamme dynamique
- Haut-parleur d'extrêmes graves désactivé
- Peut être en marche indépendamment du statut Dolby Digital
- Un seul profil d'égalisation actif à la fois (Naturel, accentuation vocale ou nocturne)

- Reduziert Dynamikbereich
- Kann unabhängig vom Dolby-Digital-Status EIN sein
- Subwoofer aus
- Es kann jeweils nur ein EQ-Profil aktiv sein (Natürlich, verbesserte Stimme, Nacht)

- Reduce el rango dinámico
- Subwoofer APAGADO
- Puede estar activa independientemente del estado de Dolby Digital
- Puede haber solo un perfil de equalización activo a la vez (natural, mejoramiento de voz, nocturno)

- Riduce la gamma dinamica
- Subwoofer spento
- Può essere On indipendentemente dallo stato Dolby Digital
- Solo un profilo alla volta dell'equalizzatore è attivo (Naturale, Potenziamento vocale, Notturna)

- Reduz a faixa dinâmica
- Subwoofer desligado
- Pode estar ATIVADO independentemente do status do Dolby Digital
- Somente um perfil de EQ ativo de cada vez (Natural, Voz melhorada ou Noturno)

- 缩小动态范围
- 低音炮关闭
- 不管杜比数字状态如何，均可“打开” (ON)
- 一次仅限一种均衡器模式有效 (自然、音效增强或夜间模式)

Klipsch[®]

KEEPERS OF THE SOUND[®]