

THE NINES

Klipsch®



INSIDE

CONTENU • CONTENIDO • INHALT • CONTENUTO • CONTEÚDO • 目录 • 同梱品

Speakers (2)

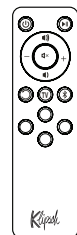
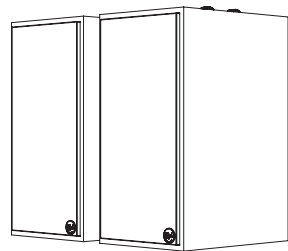

Remote

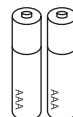

Batteries

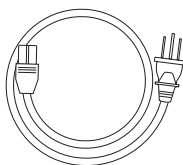

Main Power Cord

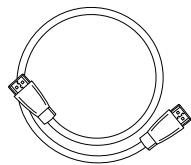

HDMI Cable

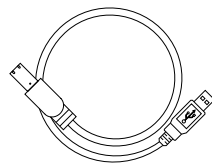

USB Cable (A to B)

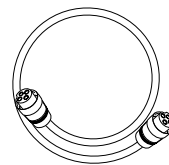

4M Speaker Cable

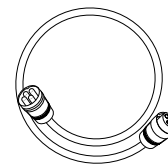

2M Extension Cable

<p>Speakers (2)</p> <p>Enceintes (2) Altavoces (2) Lautsprecher (2) Altoparlanti (2) Caixas acústicas (2) 音箱 (2) スピーカー (2)</p>	<p>Remote</p> <p>Télécommande Control remoto Fernbedienung Telecomando Control remoto 遥控器 リモート</p>	<p>Batteries</p> <p>Les Piles Pilas Batterien Baterias Batterie 電池 電池</p>	<p>Main Power Cord</p> <p>Cordon d'alimentation principal Cordón principal de alimentación Hauptnetzkaabel Cavo di alimentazione principale Cabo de alimentação principal 主电源线 主電源コード</p>	<p>HDMI Cable</p> <p>Câble HDMI Cable de HDMI HDMI-Kabel Cavo HDMI Cabo HDMI HDMI 电缆 HDMIケーブル</p>	<p>USB Cable</p> <p>Câble USB Cable USB USB-Kabel Cavo USB Cabo USB USB 电缆 USBケーブル</p>	<p>Speaker Cable</p> <p>Fil d'enceinte Cable de altavoz Lautsprecherkabel Cavo altoparlante Cabo para caixa acústica 音箱导线 スピーカーワイヤ</p>
---	---	--	--	--	---	---

PRIMARY SPEAKER (ACTIVE)

ENCEINTE DROITE (ACTIVE) • ALTAVOZ DERECHO (ACTIVO) • RECHTER LAUTSPRECHER (AKTIV) • ALTOPARLANTE DESTRO (ATTIVO) • CAIXA ACÚSTICA DIREITA (ATIVA) • 右音箱 (有源) • プライマリスピーカー(アクティブ)

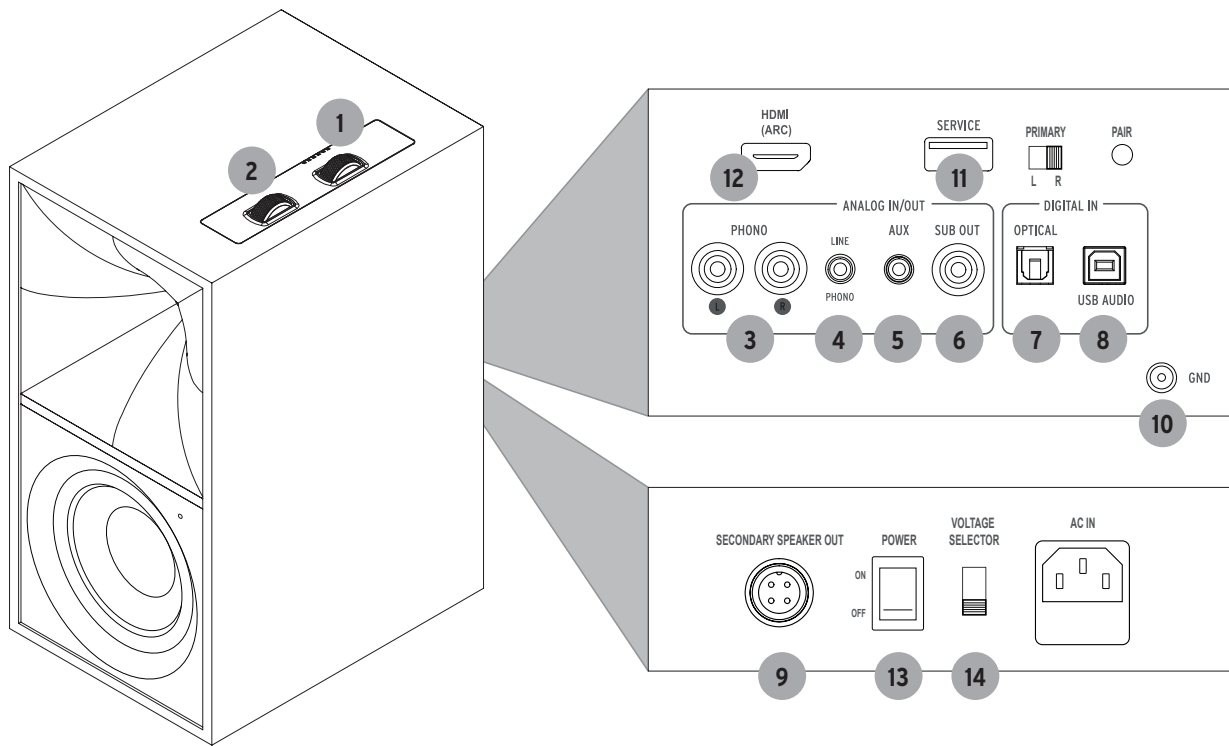

<p>1 Source Control/ LED Source Indicator</p> <p>Indicateur de source à DEL Indicador LED de fuente LED-Quellenanzeige Spia LED sorgente audio LED indicador de fonte LED 源指示灯 ソースコントロール/ LEDソースインジケータ</p>	<p>2 Volume Control</p> <p>Commande Volume/Source Control de volumen y fuente Regler Lautstärke/Quelle Comando volume/sorgente audio Control de volume/fonte 音量/源控制 音量コントロール</p>	<p>3 Phono Input</p> <p>Entrées phono Entradas de tocadiscos Phono-Eingänge Ingressi phono Entradas fono 唱机输入 フォノ入力</p>	<p>4 Phono/Line Switch</p> <p>Interrupteur Phono/Ligne Commutador de tocadiscos y línea Phono/Line-Schalter Selettore phono/linea Chave fono/linha 唱机/线路开关 フォノ/ラインスイッチ</p>	<p>5 Auxiliary 3.5mm Input</p> <p>Entrée auxiliaire de 3,5 m Entrada auxiliar de 3,5 mm 3,5-mm-AUX-Eingang Ingresso ausiliario da 3,5 mm Entrada auxiliar de 3,5 mm 補助 3.5mm 输入 補助3.5mm入力</p>
---	---	--	---	--

<p>6 Subwoofer Output</p> <p>Sortie du haut-parleur d'extrêmes graves Salida de subwoofer Subwoofer-Ausgang Uscita subwoofer Saída para subwoofer 低音炮输出 サブウーファー出力</p>	<p>7 Optical Input</p> <p>Connexion Optique Conexión Óptica Optische Verbindung Connessione Ottica Conexão Ótica 数字光纤连接 光入力</p>	<p>8 USB Audio Input</p> <p>Entrée USB Entrada de audio USB USB-Audio-Eingang Ingresso audio USB Entrada de áudio USB USB 音频输入 USオーディオ入力</p>	<p>9 Secondary Speaker Out</p> <p>Borne d'enceinte gauche Terminal de altavoz izquierdo Linker Lautsprecherterminal Terminale altoparlante sinistro Terminal da caixa acústica esquerda 左音箱端子 セカンダリースピーカー出力</p>
--	--	---	--

<p>10 Ground Screw Terminal</p> <p>Borne de la vis de raccord à la terre Terminal de tornillo de conexión a tierra Erdungsanschluss Terminale a vite di messa a terra Terminal de parafuso terra 接地螺钉端子 接地ねじ端末</p>	<p>11 Service Port</p> <p>Port de service Puerto de servicio Service-Port Porta di servizio Porta de serviço 服务端口 サービスポート</p>	<p>12 HDMI ARC</p> <p>HDMI ARC Arco HDMI HDMI ARC HDMI ARC HDMI ARC HDMI ARC HDMI ARC HDMI ARC</p>	<p>13 POWER</p> <p>Interrupteur d'alimentation Interruptor de alimentación Netzschalter Interruttore generale Chave liga/desliga 电源开关 電源 スイッチ 電源スイッチ</p>	<p>13 VOLTAGE SELECTOR</p> <p>Sélecteur de tension Selector de voltaje Spannungswähler Selettore di tensione Seletor de tensão 電圧セレクター 电压选择器</p>
---	--	---	---	---

SETUP

INSTALLATION • CONFIGURACIÓN • SETUP • INSTALLAZIONE • INSTALAÇÃO • 设置 • 設定

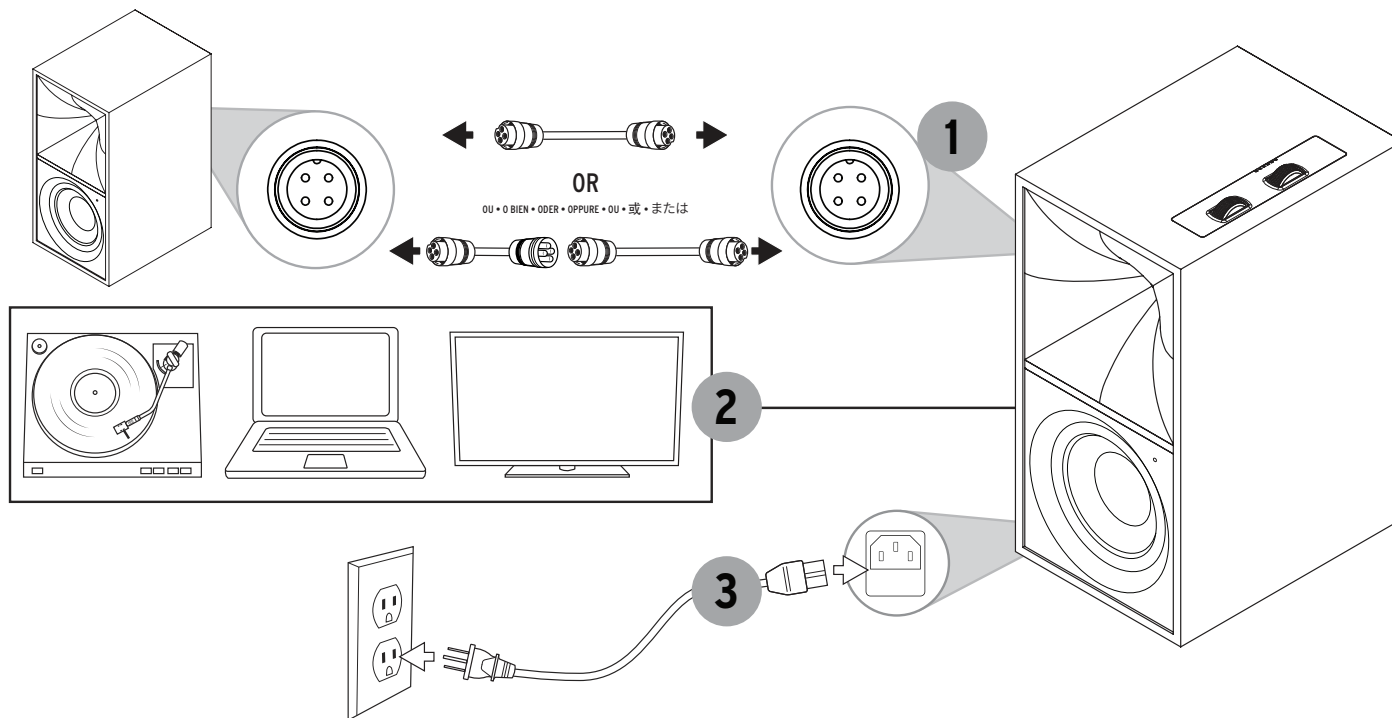

QUICK SETUP - INSTALL THE KLIPSCH CONNECT APP

APPLICATION KLIPSCH CONNECT • APLICACIÓN KLIPSCH CONNECT • KLIPSCH CONNECT APP • APP KLIPSCH CONNECT • APLICATIVO KLIPSCH CONNECT • KLIPSCH CONNECT应用 • KLIPSCH CONNECTアプリ



Getting Started
Product Registration
Virtual Remote Control and EQ

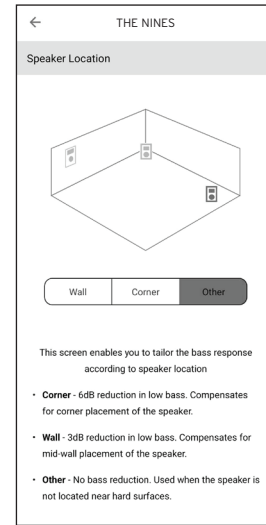
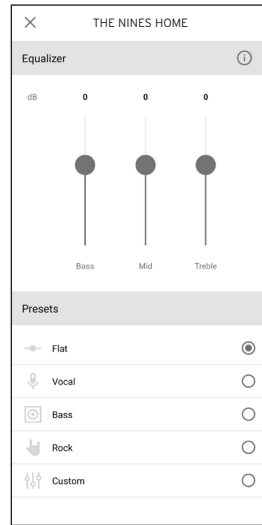
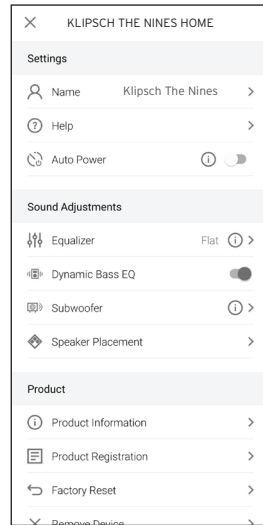
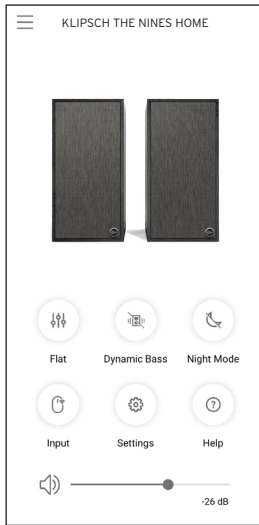

CONNECTIONS - HDMI-ARC (IF TV HAS NO HDMI-ARC OUT SEE NEXT PAGE)

CONNEXIONS - HDMI-ARC • CONEXIONES - HDMI-ARC • ANSCHLÜSSE - HDMI-ARC • CONNESSIONI - HDMI-ARC • CONEXÕES - HDMI-ARC • 连接 - HDMI-ARC • 接続 - HDMI-ARC

A Basic TV HDMI input will not transfer the TV audio signal to the speakers. The speakers must be connected to the TV's HDMI-ARC output, optical output, or analog audio output in order to receive TV Audio.

Une entrée TV HDMI de base ne transférera pas le signal audio TV vers haut-parleurs. Les Nines ne recevra l'audio TV qu'au moyen d'une connexion HDMI-ARC (avec CEC sur MARCHE (ON)), Optique ou Analogique.

Una entrada básica de HDMI de una TV no transfiere la señal de audio de haut-parleurs. Les Nines solo recibirá el audio de la TV a través de una conexión óptica o análoga de tipo HDMI-ARC (con el CEC encendido).

Ein einfacher HDMI-Eingang kann das TV-Audiosignal nicht an der Lautsprecher übertragen. Die Nines kann das TV-Audiosignal nur über HDMI-ARC (bei aktiviertem CEC), eine optische oder analoge Verbindung empfangen.

Il normale input televisivo HDMI non permette di trasmettere i segnali audio televisivi alla altoparlanti. La Nines riceve i segnali audio televisivi soltanto dai connettori HDMI-ARC (con CEC impostata su ON), ottici o analogici.

Uma entrada HDMI TV básica não transfere o sinal de áudio da TV para a alto-falante. Os Nines recebe áudio da TV somente através de uma conexão HDMI-ARC (com CEC ligado), óptica ou analógica.

一个基本的电视 HDMI 输入端不会将电视音频信号传送到声霸扬声器。The Nines 声霸扬声器只能通过 HDMI-ARC (CEC 打开状态下) 接收 电视音频、光学或类比信号。

ベーシックTV HDMI入力は、TV音声信号をスピーカーに送信しません。TV音声を受信するには、NinesをTVのHDMIARC出力、光出力、またはアナログ音声出力に接続する必要があります。

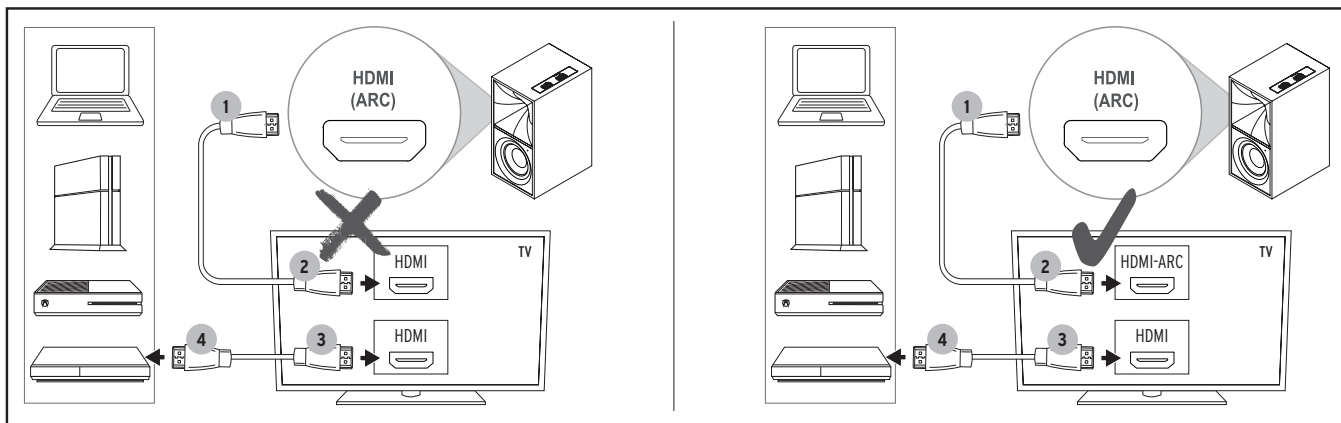

Si votre téléviseur n'a pas de sortie HDMI-ARC, reportez-vous à la page suivante

Si el televisor no tiene salida HDMI-ARC, vea la página siguiente

Wenn Fernseher nicht über einen HDMI-ARC-Ausgang verfügt, siehe nächste Seite

Se il televisore non ha un'uscita HDMI-ARC vedere alla pagina successiva

Se a TV não tiver saída HDMI-ARC, consulte a próxima página

如果电视没有 HDMI-ARC 输出，请参见下一页

(TVにHDMI-ARC出力がない場合は次のページをご覧ください)

CONNECTIONS - TV

CONNEXIONS - TV • CONEXIONES DEL TELEVISOR • ANSCHLÜSSE - TV • CONNESSIONI - TV • CONEXÕES - TV • 连接 - 电视 • 接続 - TV

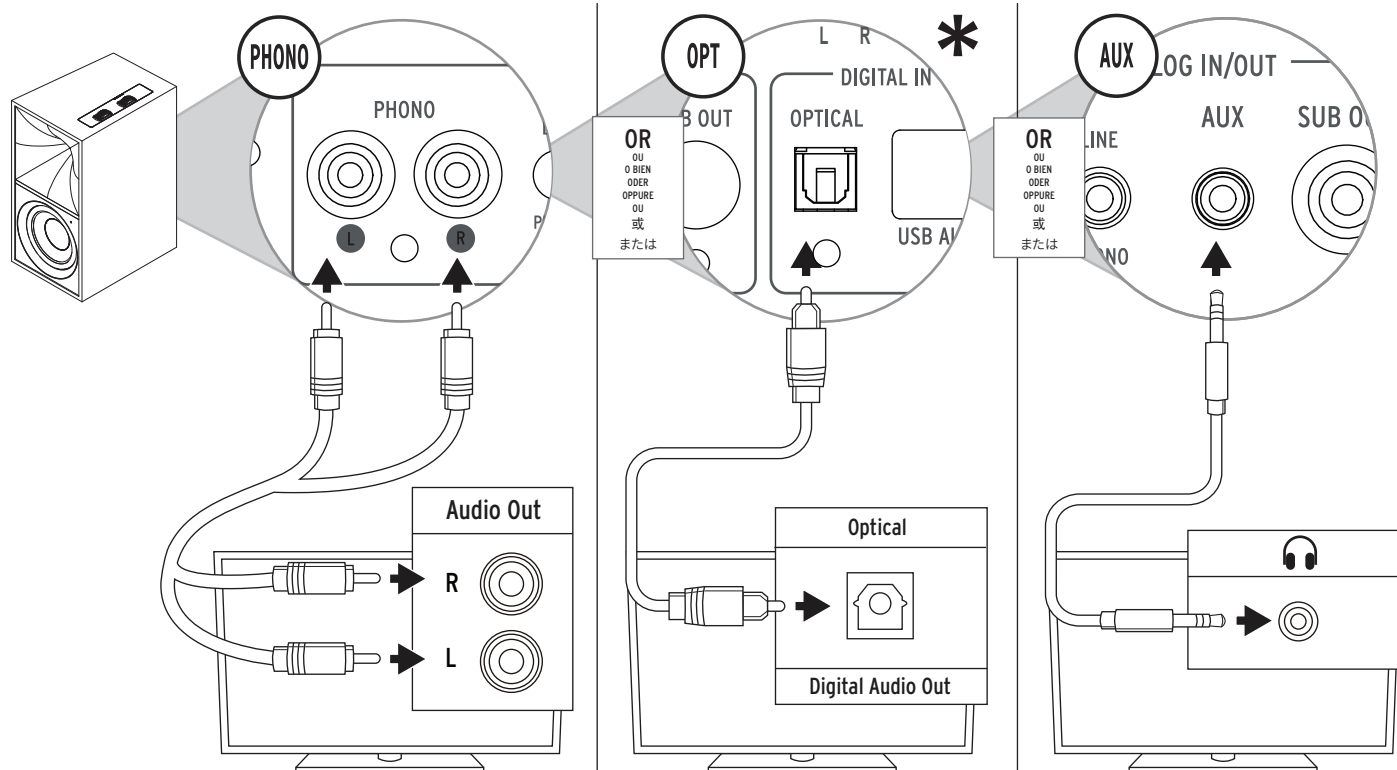

* Your TV will need to be set to PCM (or Stereo Only)

* Votre télévision devra être réglée sur la sortie MIC (Modulation d'impulsion codée) (ou stéréo seulement) * Su televisor debe fijarse en PCM (o Solo estéreo) * Ihr Fernseher muss auf PCM (oder Nur Stereo) eingestellt sein * Il televisore deve essere impostato su PCM (o solo stereo)

* A TV precisa ser configurada para PCM (ou apenas estéreo) * 需要将您的电视设置为 PCM (或仅设置为“立体声”) * TVをPCM (またはステレオのみ) に設定する必要があります

CONNECTIONS - COMPUTER

CONNEXIONS - ORDINATEUR • CONEXIONES DE LA COMPUTADORA • ANSCHLÜSSE - COMPUTER • CONNESSIONI - COMPUTER • CONEXÕES - COMPUTADOR • 连接 - 计算机 • 接続 - コンピュータ

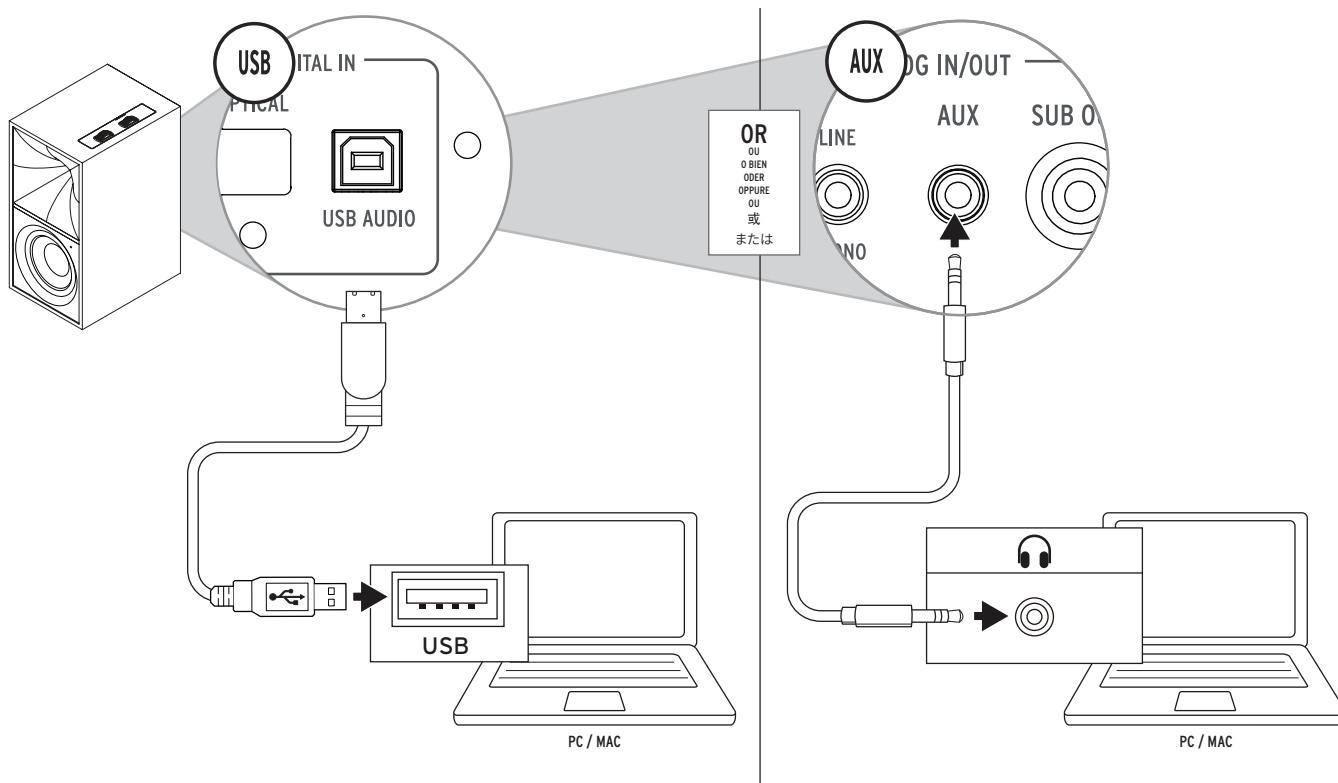

CONNECTIONS - TURNTABLE

CONNEXIONS - PLATINES • CONEXIONES DEL TOCADISCOS • ANSCHLÜSSE - PLATTENSPIELER • CONNESSIONI - GIRADISCHI • CONEXÕES - TOCA-DISCOS • 连接-唱盘 • 接続 - ターンテーブル

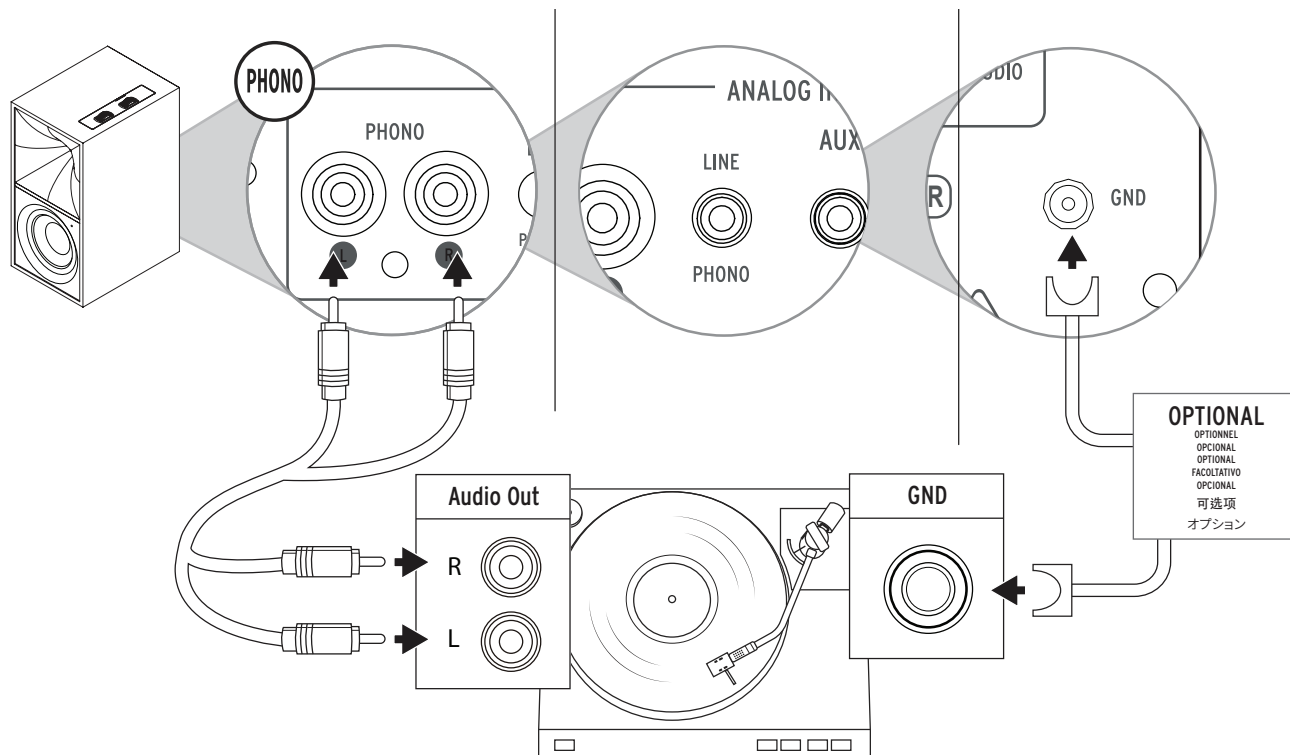

REMOTE

TÉLÉCOMMANDE • CONTROL REMOTO • FERNBEDIENUNG • TELECOMANDO • CONTROLE REMOTO • 遥控器 • リモート

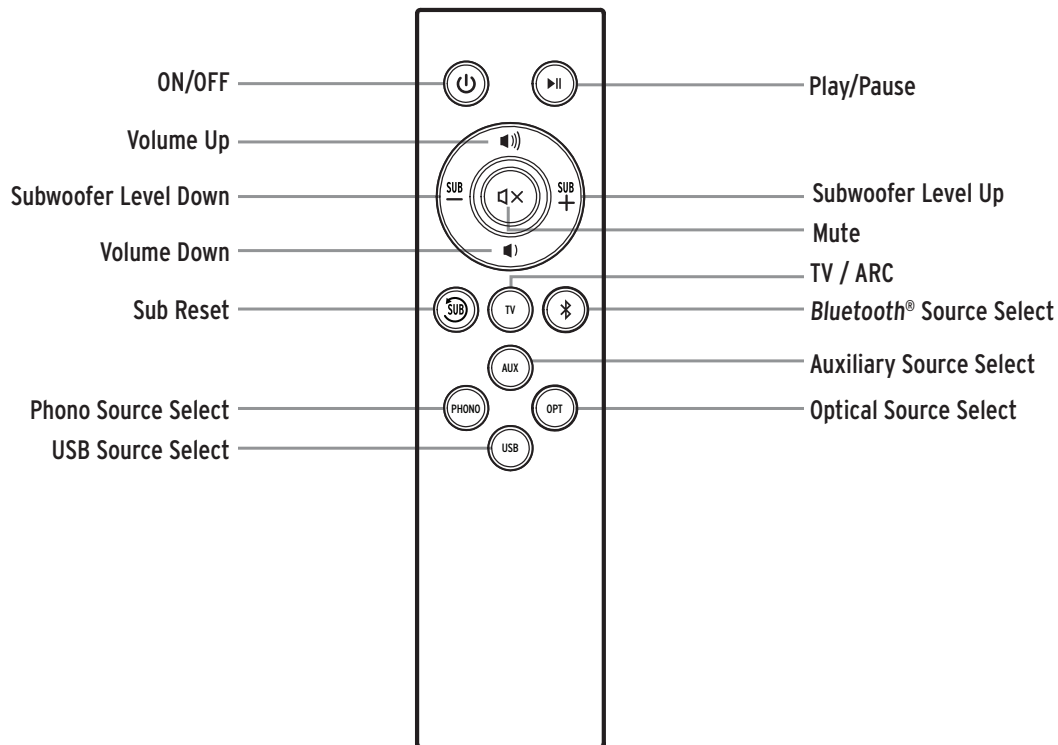

IR REMOTE CONTROL CODES

ON / OFF	0x 807F 1AE5
Mute	0x 807F 01FE
Subwoofer Level Up	0x 807F 07F8
Subwoofer Level Down	0x 807F 0AF5
Volume Up	0x 807F 03FC
Volume Down	0x 807F 06F9
TV / ARC	0x 807F 19E6
Subwoofer Level Reset	0x 807F 3EC1
Play/Pause	0x 807F 2IDE
Phono Source Select	0x 807F 0FF0
Auxiliary Source Select	0x 807F 0EF1
Digital Optical Source Select	0x 807F 0CF3
USB Source Select	0x 807F 12ED
Bluetooth® Source Select	0x 807F 0DF2

<p>ON / OFF</p> <p>Sous tension / Hors tension Encendido / Apagado Ein / Aus Acceso / Spento Ligar / Desligar 开/关 オン/オフ</p>	<p>Mute</p> <p>Sourdine Silenciador Stummhaltung Disattivazione audio Desativar áudio 静音 無音</p>	<p>Subwoofer Level Up</p> <p>Augmenter le son du caisson de basses Subida de nivel de subwoofer Subwoofer-Pegel Plus Aumento livello subwoofer Aumentar nível de volume do subwoofer 低音炮电平上升 サブウーファーレベルアップ</p>	<p>Subwoofer Level Down</p> <p>Baisser le son du caisson de basses Bajada de nivel de subwoofer Subwoofer-Pegel Minus Riduzione livello subwoofer Diminuir nível de volume do subwoofer 低音炮电平下降 サブウーファーレベルダウン</p>	<p>Volume Up</p> <p>Volume haut Subida de volumen Lauter Aumento volume Aumentar o volume 音量増大 音量アップ</p>	<p>Volume Down</p> <p>Volume bas Bajada de volumen Leiser Riduzione volume Diminuir o volume 音量减小 音量ダウン</p>
--	--	---	--	---	--

<p>Subwoofer Level Reset</p> <p>Réinitialisation le son du caisson de basses Restablecimiento de nivel de subwoofer Subwoofer-Pegel zurücksetzen Ripristino livello subwoofer Restabelecer nível de volume do subwoofer 低音炮电平复位 サブウーファーレベル再設定</p>	<p>TV</p> <p>TÉLÉVISION TV FERNSEHER TV TELEVISÃO 电视 TV</p>	<p>Play/Pause</p> <p>Lecture/pause Reproducción/pausa Wiedergabe/Pause Riproduzione / Pausa Reproduzir/Pausar 播放/暂停 再生/停止</p>
--	--	--

<p>Phono Source Select</p> <p>Sélection de la source Phono Selección de fuente de tocadiscos Phone-Quellenwahl Selezione sorgente phono Seleção de fonte fono 唱机源选择 フォノソース選択</p>	<p>Auxiliary Source Select</p> <p>Sélection de la source auxiliaire Selección de fuente auxiliar AUX-Quellenwahl Selezione sorgente auxiliaia Seleção de fonte auxiliar 辅助源选择 補助ソース選択</p>	<p>Digital Optical Source Select</p> <p>Sélection de la source optique numérique Selección de fuente óptica digital Digital-optische Quellenwahl Selezione segnale ottico digitale Seleção de fonte ótica digital 数字光学源选择 光デジタルソース選択</p>	<p>USB Source Select</p> <p>Sélection de la source USB Selección de fuente USB USB-Quellenwahl Selezione sorgente USB Seleção de fonte USB USB 源选择 USBソース選択</p>	<p>Bluetooth® Source Select</p> <p>Sélection de la source Bluetooth® Selección de fuente Bluetooth® Bluetooth®-Quellenwahl Selezione segnale Bluetooth® Seleção de fonte Bluetooth® 蓝牙源选择 Bluetooth® ソース選択</p>
---	--	---	--	---

BLUETOOTH® WIRELESS TECHNOLOGY

TECNOLOGÍA INALÁMBRICA **BLUETOOTH®** • CONFIGURACIÓN DE TECNOLOGÍA WIRELESS **BLUETOOTH®** • DRAHTLOSE **BLUETOOTH®**-TECHNOLOGIE-SETUP • CONFIGURAZIONE TECNOLOGIA WIRELESS **BLUETOOTH®** • CONFIGURAÇÃO DE TECNOLOGIA SEM FIO **BLUETOOTH®** • **BLUETOOTH®** 蓝牙无线电技术 • ASPD

PAIR

CONNEXION
CONEXIÓN
VERBINDEN
COLLEGAMENTO
CONECTAR
连接
ペアリング

1 Hold 3 Seconds
Appuyer pendant 3 secondes
Mantenga oprimido durante 3 segundos
3 Sekunden gedrückt halten
Tenere premuto per 3 secondi
Manter pressionado por 3 segundos
保持 3 秒
3秒間押します

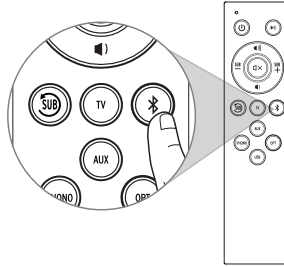

OR
OU
O BIEN
ODER
OPPURE
OU
或
または

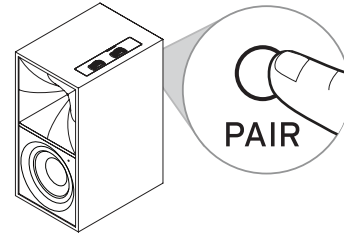

2 Flashing

Flashing
Clignotant
Destello
Blinkt
Lampeggiante
Intermittente
闪烁
点滅

3

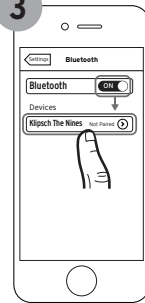

4

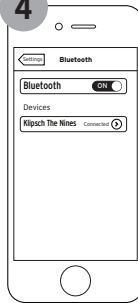

5 Solid

Solid
Continu
Continuo
Dauerhaft
Luce fissa
Constante
常亮
点灯

Example only. Your device may differ.

• À titre d'exemple seulement. Votre appareil peut être différent. • Este es solo un ejemplo. Es posible que su dispositivo sea diferente. • Nur als Beispiel. Ihr Gerät kann anders aussehen
• Solo a titolo esemplificativo. Lo specifico dispositivo può essere diverso. • Apenas para exemplo. O dispositivo pode ser diferente. • 仅为示例。实际设备可能有所不同。例のみ。デバイスによって異なります。

RECONNECT

RECONNECTER
RECONNECTAR
ERNEUT VERBINDEN
RICONNESSIONE
RECONNECTAR
重新连接
再接続

1



2 Press x1

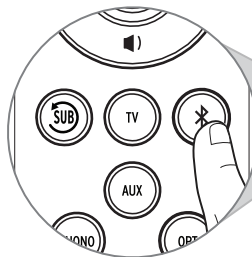

Press x1

Appuyer 1 fois
Oprima 1 vez
Ix drücken
Premere 1 volta
Pressionar uma vez
按 1 次
1回押します

3 Solid

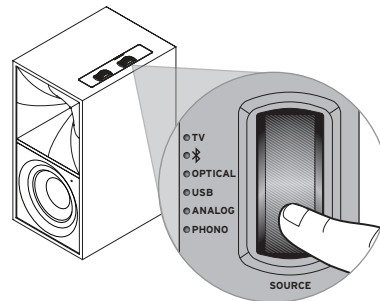

Solid

Continuo
Dauerhaft
Luce fissa
Constante
常亮
点灯

SUBWOOFER OUTPUT

SORTIE DU HAUT-PARLEUR D'EXTRÊMES GRAVES • SALIDA DE SUBWOOFER • SUBWOOFER-AUSGANG • USCITA SUBWOOFER • SAÍDA PARA SUBWOOFER • 低音炮输出 • サブウーファー出力

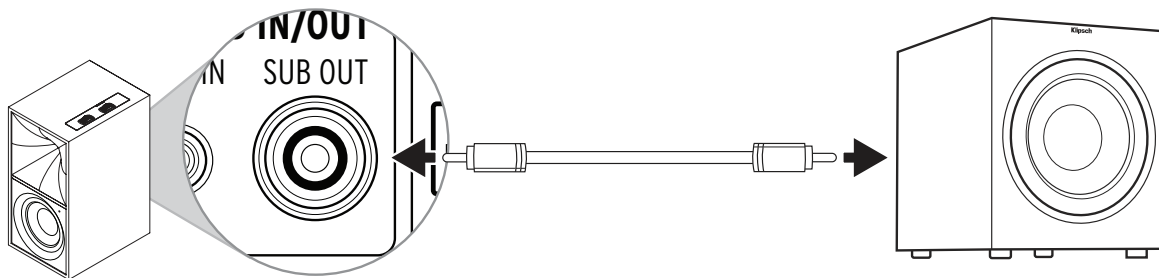

LED SOURCE INDICATOR

INDICATEUR DE SOURCE À DEL • INDICADOR LED DE FUENTE • LED-QUELLENANZEIGE • SPIA LED SORGENTE AUDIO • LED INDICADOR DE FONTE • LED 源指示灯 • LEDソースインジケータ

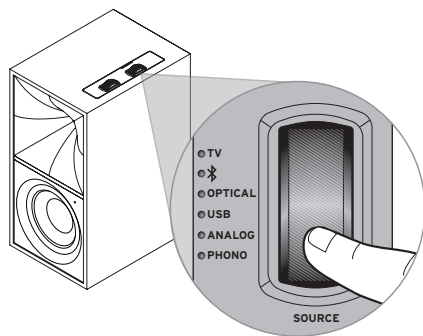

<p>Bluetooth® Input Entrée Bluetooth® Entrada Bluetooth® Bluetooth®-Eingang Ingresso Bluetooth® Entrada Bluetooth® LED 源指示灯 Bluetooth® 入力</p>	<p>Phono Input Entrée phono Entrada de tocadiscos Phono-Eingang Ingresso phono Entrada fono 唱机输入 フォノ入力</p>	<p>Auxiliary Input Entrée auxiliaire Entrada auxiliar AUX-Eingang Ingresso auxiliar Entrada auxiliar 辅助输入 補助入力</p>
<p>Optical Input Connexion Optique Conexión Óptica Optische Verbindung Connessione Ottica Conexão Ótica 数字光纤连接 光入力</p>	<p>USB Audio Input Entrée audio USB Entrada de audio USB USB-Audio-Eingang Ingresso audio USB Entrada de áudio USB USB 音频输入 USB音声入力</p>	<p>TV La télé TV Fernseher TV Televisão 电视 TV</p>

SELECT SOURCE

SELECTIONNER LA SOURCE • SELECCIÓN DE FUENTE • QUELLE WÄHLEN • SELEZIONE SORGENTE AUDIO • SELEÇÃO DA FONTE • 选择源 • ソース選択

NOTE: You may notice slightly different volume levels between different sources. This is by design to ensure optimal gain structure from source to source.

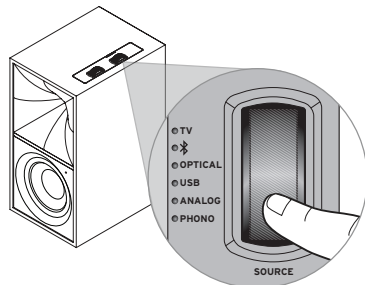

Scroll

Appuyer
Oprima
Drücken
Premere
Pressionar
滚动
スクロール

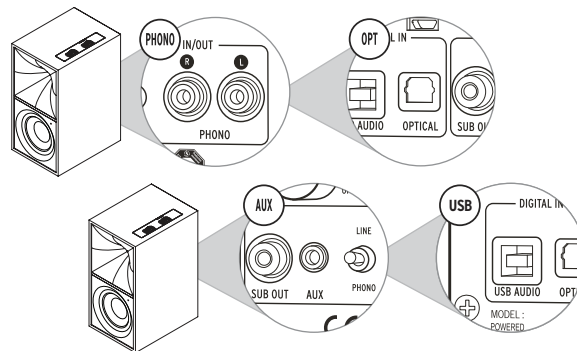

CARE AND CLEANING

ENTRETIEN ET NETTOYAGE • CUIDADO Y LIMPIEZA • PFLEGE UND REINIGUNG • CURA E PULIZIA • CUIDADOS E LIMPEZA • 保养与清洁 • お手入れと掃除

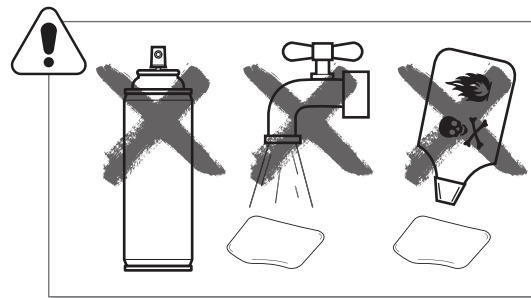
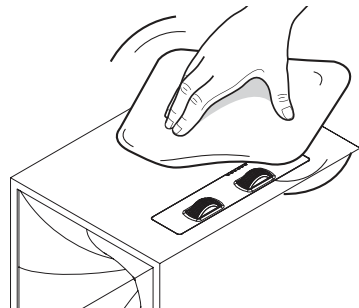

* USE MICROFIBER CLOTHS ONLY

*Utilisez des chiffons en microfibrés seulement

*Use solamente paños de microfibra

*Nur Mikrofasertücher verwenden

*Usare solo panni in microfibra

*Use somente tecidos de microfibra

*仅限使用超细纤维布

* マイクロファイバー 製布のみを使用します

DYNAMIC BASS EQ

ÉGALISATION DYNAMIQUE DES BASSES • ECUALIZACIÓN DE BAJOS DINÁMICOS • DYNAMISCHER BASS-EQ • EQUALIZZAZIONE DEI BASSI DINAMICA • EQUALIZAÇÃO DINÂMICA DE GRAVES • 动态低音均衡 • 重低音EQ

Dynamic Bass EQ applies loudness correction to automatically adjust low frequency levels as volume changes.

L'égalisation dynamique des graves applique une correction du volume sonore pour régler automatiquement le niveau des basses fréquences au fur et à mesure des variations de volume.

La ecualización de bajos dinámicos corrige la sonoridad para ajustar automáticamente los niveles de las frecuencias bajas según los cambios de volumen.

Der Dynamische Bass-EQ setzt eine Lautstärkeregelung ein, um bei Lautstärkeänderungen die Tieffrequenzpegel automatisch anzupassen.

L'equalizzazione dei bassi dinamica applica la correzione della sonorità per regolare automaticamente i livelli a bassa frequenza in funzione delle variazioni del volume.

A equalização dinâmica de graves aplica correção de intensidade para ajustar automaticamente os níveis de baixa frequência quando há mudança no volume.

动态低音均衡器应用响度校正功能，随音量变化自动调节低音电平。

重低音EQは、音量の変化に伴い低周波レベルを自動的に調整するためのラウドネス補正に適用されます。

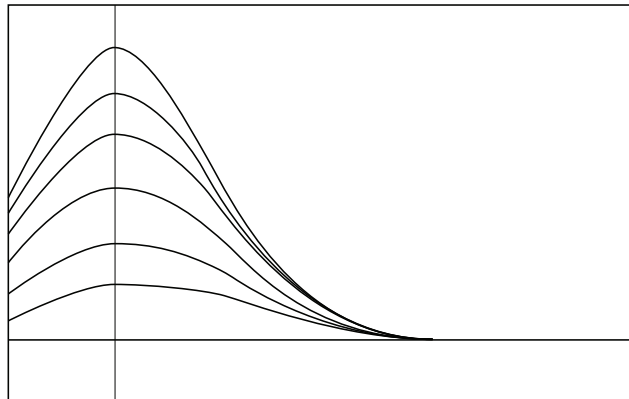

For best results, increase input source volume to maximum.

Pour de meilleurs résultats, augmentez au maximum le volume de la source d'entrée.

Para obtener resultados óptimos, aumente el volumen de la fuente de entrada al máximo.

Steigern Sie am besten die Lautstärke der Eingangsquelle aufs Maximum.

Per ottenere risultati ottimali, aumentare al massimo il volume della sorgente audio.

Para obter melhores resultados, aumente o volume da fonte de entrada para o máximo.

为获得最佳效果，请将输入音量增加到最大。

最善の結果を得るには、入力ソースの音量を最大にしてください。

DISABLE DYNAMIC BASS EQ

DÉSACTIVER L'ÉGALISEUR DES GRAVES DYNAMIQUE • DESACTIVAR LA ECUALIZACIÓN DE BAJOS DINÁMICOS • DYNAMISCHEN BASS-EQ DEAKTIVIEREN • DISABILITA EQUALIZZAZIONE DEI BASSI DINAMICA • DESATIVAR A EQUALIZAÇÃO DINÂMICA DE GRAVES • 禁用动态低音均衡器 • 重低音EQの無効化

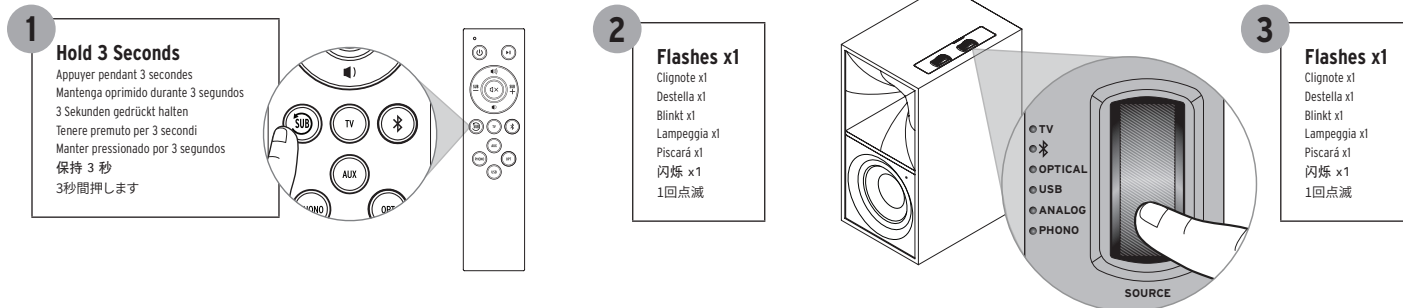

ENABLE DYNAMIC BASS EQ

ACTIVER L'ÉGALISEUR DES GRAVES DYNAMIQUE • ACTIVAR LA ECUALIZACIÓN DE BAJOS DINÁMICOS • AKTIVIEREN BASS-EQ DEAKTIVIEREN • ABILITA EQUALIZZAZIONE DEI BASSI DINAMICA • ATIVAR A EQUALIZAÇÃO DINÂMICA DE GRAVES • 启用动态低音均衡器 • ディープベースEQを有効にする

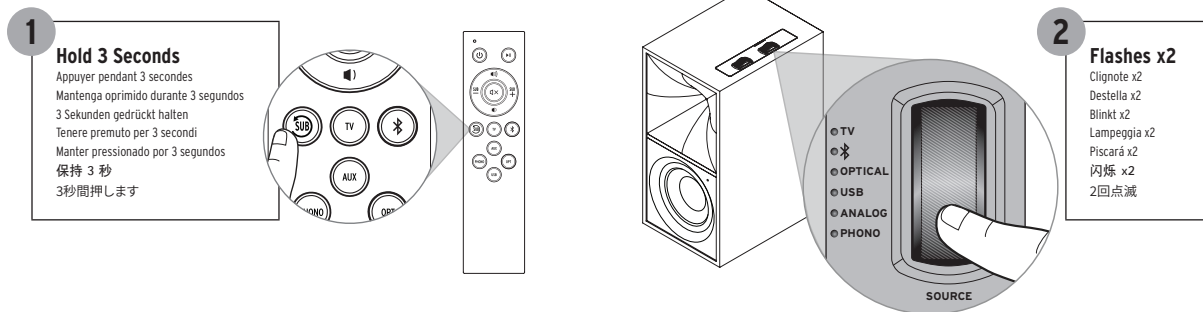

FACTORY RESET

RÉINITIALISATION • RESTABLECIMIENTO DE FÁBRICA • RÜCKSETZUNG AUF WERKSEINSTELLUNG • RIPRISTINO IMPOSTAZIONI DI FABBRICA • RESTABELECIMENTO DAS CONFIGURAÇÕES DE FÁBRICA • 恢复出厂设置 • 工場出荷時設定リセット

1 Select Source to Phono, Analog, Digital or USB

Sélectionner la source Phono, auxiliaire, Optique ou USB

Seleccionar tocadiscos, auxiliar, Óptica o bien USB

Quellenwahl auf Phono, AUX, Optische oder USB

Selezionare il segnale per phono, ausiliaria, Ottica oppure USB

Selecione a fonte para o fono, auxiliar, Ótica ou USB

选择源至唱机, 辅, 数字或USB

ソースをフオン、アナログ、デジタルまたはUSBから選択します

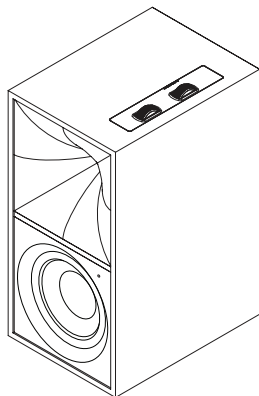

2

Press and Hold

Appuyer et Maintenir

Presione y mantenga

Drücken und halten

Tieni premuto

Pressione e segure

按下并保持

押し続けます

3

Press

Appuyer

Oprima

drücken

Premere

Pressionar

按

押す

4

Release

Libération

Lanzamiento

Freisetzung

Liberare

Lançamento

发布

離す

5

Flashes 10 Seconds

Cignote 10 secondes

Destella 10 segundos

10 Sekunden Blink

Lampeggia 10 secondi

Piscará 10 segundos

闪烁 10 秒

10秒間点滅します

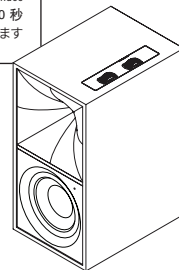

NOTE Factory Reset will clear the Bluetooth® pairing history

REMARQUE La réinitialisation aux réglages d'usine effacera l'historique d'association Bluetooth®

NOTA El restablecimiento de fábrica borra el historial de vinculación de Bluetooth®

HINWEIS Rücksetzung auf Werkseinstellungen löscht die gespeicherten Bluetooth®-Kopplungen

NOTA Il ripristino delle impostazioni di fabbrica cancella la cronologia delle associazioni Bluetooth®

OBSERVAÇÃO O restabelecimento das configurações de fábrica apagará o histórico de emparelhamento Bluetooth®

注 工場出荷時設定リセットで、Bluetooth® ペ어링履歴が消去されます

注 工場出荷時設定リセットで、Bluetooth® ペ어링履歴が消去されます

注 工場出荷時設定リセットで、Bluetooth® ペ어링履歴が消去されます

注 工場出荷時設定リセットで、Bluetooth® ペ어링履歴が消去されます

注 工場出荷時設定リセットで、Bluetooth® ペ어링履歴が消去されます

注 工場出荷時設定リセットで、Bluetooth® ペ어링履歴が消去されます

注 工場出荷時設定リセットで、Bluetooth® ペ어링履歴が消去されます

注 工場出荷時設定リセットで、Bluetooth® ペ어링履歴が消去されます

注 工場出荷時設定リセットで、Bluetooth® ペ어링履歴が消去されます

注 工場出荷時設定リセットで、Bluetooth® ペ어링履歴が消去されます

注 工場出荷時設定リセットで、Bluetooth® ペ어링履歴が消去されます

注 工場出荷時設定リセットで、Bluetooth® ペ어링履歴が消去されます

注 工場出荷時設定リセットで、Bluetooth® ペ어링履歴が消去されます

注 工場出荷時設定リセットで、Bluetooth® ペ어링履歴が消去されます

注 工場出荷時設定リセットで、Bluetooth® ペ어링履歴が消去されます

注 工場出荷時設定リセットで、Bluetooth® ペ어링履歴が消去されます

注 工場出荷時設定リセットで、Bluetooth® ペ어링履歴が消去されます

REMOTE CONTROL CODES (FOR UNIVERSAL OR CABLE REMOTES)

RCA*	41609 OR 43915
DIRECTV	31609
XFINITY**	30531 OR 31023
BRIGHT HOUSE	288
AT&T (SILVER)	5156 OR 5023
AT&T (BLACK)	5156

* MUST HAVE AUDIO/AUX BUTTON OR AUDIO-SB BUTTON

** RED CENTER BUTTON

NOTE: NOT ALL UNIVERSAL REMOTES ARE COMPATIBLE

HEX CODES - SET 1	
VOLUME UP	0x 856A 9F60
VOLUME DOWN	0x 856A 9E61
MUTE	0x 856A 9966

HEX CODES - SET 3	
VOLUME UP	0x A55A 0AF5
VOLUME DOWN	0x A55A 0BF4
MUTE	0x A55A 12ED

HEX CODES - SET 4	
VOLUME UP	0x 859A 817E
VOLUME DOWN	0x 859A 827D
MUTE	0x 859A 8778

TROUBLESHOOTING

Klipsch[®]

KEEPERS OF THE SOUND[™]